

2 MHz / 3 MHz Ultra Small Step Down Converter in 1x1.5 SON Package

FEATURES

- 2 MHz / 3 MHz Switch Frequency
- Up to 94% Efficiency
- Output Peak Current up to 500mA
- Excellent AC and Transient Load Regulation
- High PSRR (up to 90dB)
- Small External Output Filter Components 1 μ H/ 4.7 μ F
- V_{IN} range from 2.05V to 6V
- Optimized Power Save Mode For Low Output Ripple Voltage
- Forced PWM Mode Operation
- Typ. 22 μ A Quiescent Current
- 100% Duty Cycle for Lowest Dropout
- Small 1 x 1.5 x 0.6mm³ SON Package
- 12 mm² Minimum Solution Size
- Supports 0.6 mm Maximum Solution Height
- Soft Start with typ. 100 μ s Start Up Time

APPLICATIONS

- LDO Replacement
- Portable Audio, Portable Media
- Cell Phones
- Low Power Wireless
- Low Power DSP Core Supply
- Digital Cameras

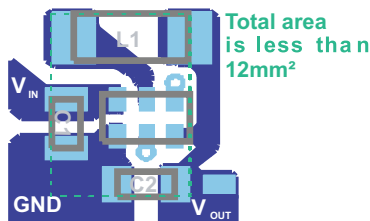
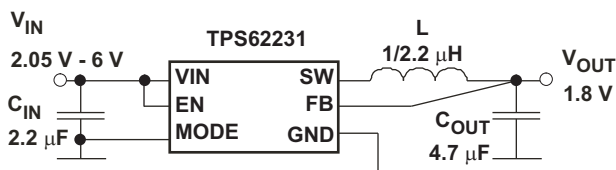

DESCRIPTION

The TPS6223X device family is a high frequency synchronous step down DC-DC converter optimized for battery powered portable applications. It supports up to 500mA output current and allows the use of tiny and low cost chip inductors and capacitors.

With a wide input voltage range of 2.05V to 6V the device supports applications powered by Li-Ion batteries with extended voltage range. The minimum input voltage of 2.05V allows as well the operation from Li-primary or two alkaline batteries. Different fixed output voltage versions are available from 1.0V to 3.3V.

The TPS6223X series features switch frequency up to 3.8MHz. At medium to heavy loads, the converter operates in PWM mode and automatically enters Power Save Mode operation at light load currents to maintain high efficiency over the entire load current range.

Because of its excellent PSRR and AC load regulation performance, the device is also suitable to replace linear regulators to obtain better power conversion efficiency.

The Power Save Mode in TPS6223X reduces the quiescent current consumption down to 22 μ A during light load operation. It is optimized to achieve very low output voltage ripple even with small external component and features excellent ac load regulation.

For very noise sensitive applications, the device can be forced to PWM Mode operation over the entire load range by pulling the MODE pin high. In the shutdown mode, the current consumption is reduced to less than 1 μ A. The TPS6223X is available in a 1 x 1.5mm² 6 pin SON package.



Please be aware that an important notice concerning availability, standard warranty, and use in critical applications of Texas Instruments semiconductor products and disclaimers thereto appears at the end of this data sheet.



These devices have limited built-in ESD protection. The leads should be shorted together or the device placed in conductive foam during storage or handling to prevent electrostatic damage to the MOS gates.

ORDERING INFORMATION⁽¹⁾

T _A	PART NUMBER ⁽²⁾	OUTPUT VOLTAGE	FREQUENCY [MHz]	PACKAGE DESIGNATOR	ORDERING	PACKAGE MARKING
-40°C to 85°C	TPS62230	2.5 V	3	DRY	TPS62230DRY	GV
	TPS62231	1.8 V	3	DRY	TPS62231DRY	GW
	TPS62232	1.2 V	3	DRY	TPS62232DRY	GX
	TPS62239	1.0 V	3	DRY	TPS62239DRY	OP
	TPS622311	1.1V	2	DRY	TPS622311DRY	PA
	TPS622315	1.15V	2	DRY	TPS622315DRY	RI
	TPS62235	1.2V	2	DRY	TPS62235DRY	OQ
	TPS622318	1.25V	3	DRY	TPS622318DRY	ST
	TPS622313	1.3 V	3	DRY	TPS622313DRY	QF
	TPS622314	1.5 V	3	DRY	TPS622314DRY	QG
	TPS62236	1.85V	2	DRY	TPS62236DRY	OR
	TPS622312	2.0 V	3	DRY	TPS622312DRY	QE
	TPS62234	2.1 V	3	DRY	TPS62234DRY	OH
	TPS62238	2.25 V	3	DRY	TPS62238DRY	ON
	TPS622310	2.3 V	3	DRY	TPS622310DRY	OT
	TPS622316	2.7 V	3	DRY	TPS622316DRY	RJ
	TPS622317	2.9 V	3	DRY	TPS622317DRY	RK
	TPS62233	3.0 V	3	DRY	TPS62233DRY	OG
	TPS62237	3.3V	2	DRY	TPS62237DRY	OS

- (1) For detailed ordering information see the PACKAGE OPTION ADDENDUM at the end of this data sheet.
 (2) The DRY package is available in tape on reel. Add R suffix to order quantities of 3000 parts per reel, T suffix for 250 parts per reel.

ABSOLUTE MAXIMUM RATINGS

over operating free-air temperature range (unless otherwise noted)⁽¹⁾

		VALUE	UNIT
V _I	Voltage at VIN and SW Pin ⁽²⁾	-0.3 to 7	V
	Voltage at EN, MODE Pin ⁽²⁾	-0.3 to V _{IN} +0.3, ≤7	V
	Voltage at FB Pin ⁽²⁾	-0.3 to 3.6	V
Peak output current		internally limited	A
ESD rating ⁽³⁾	HBM Human body model	2	kV
	CDM Charge device model	1	
	Machine model	200	V
Power dissipation		Internally limited	
T _J	Maximum operating junction temperature	-40 to 125	°C
T _{stg}	Storage temperature range	-65 to 150	°C

- (1) Stresses beyond those listed under *absolute maximum ratings* may cause permanent damage to the device. These are stress ratings only and functional operation of the device at these or any other conditions beyond those indicated under *recommended operating conditions* is not implied. Exposure to absolute-maximum-rated conditions for extended periods may affect device reliability.
 (2) All voltage values are with respect to network ground terminal.
 (3) The human body model is a 100-pF capacitor discharged through a 1.5-kΩ resistor into each pin. The machine model is a 200-pF capacitor discharged directly into each pin.

DISSIPATION RATINGS⁽¹⁾

PACKAGE	R _{θJA}	POWER RATING FOR T _A ≤ 25°C	DERATING FACTOR ABOVE T _A = 25°C
1 × 1.5 SON	234°C/W ⁽²⁾	420 mW	4.2 mW/°C

- (1) Maximum power dissipation is a function of T_{J(max)}, θ_{JA} and T_A. The maximum allowable power dissipation at any allowable ambient temperature is P_D = [T_{J(max)} – T_A] / θ_{JA}.
- (2) This thermal data is measured with high-K board (4 layers board according to JESD51-7 JEDEC standard).

RECOMMENDED OPERATING CONDITIONS

 operating ambient temperature T_A = –40 to 85°C (unless otherwise noted)⁽¹⁾

		MIN	NOM	MAX	UNIT
Supply voltage V _{IN} ⁽²⁾		2.05		6	V
Effective inductance			2.2		μH
Effective capacitance		2.0	4.7		μF
Recommended minimum supply voltage	V _{OUT} ≤ V _{IN} - 1 V ⁽³⁾	500 mA maximum I _{OUT} ⁽⁴⁾		3.0	3.6
		350mA maximum I _{OUT} ⁽⁵⁾		2.5	2.7
	V _{OUT} ≤ 1.8V	60 mA maximum output current ⁽⁵⁾		2.05	
Operating virtual junction temperature range, T _J		–40		125	°C

- (1) In applications where high power dissipation and/or poor package thermal resistance is present, the maximum ambient temperature may have to be derated. Maximum ambient temperature (T_{A(max)}) is dependent on the maximum operating junction temperature (T_{J(max)}), the maximum power dissipation of the device in the application (P_{D(max)}), and the junction-to-ambient thermal resistance of the part/package in the application (θ_{JA}), as given by the following equation: T_{A(max)} = T_{J(max)} – (θ_{JA} × P_{D(max)}).
- (2) The minimum required supply voltage for startup is 2.05 V. The part is functional down to the falling UVL (Under Voltage Lockout) threshold.
- (3) For a voltage difference between minimum V_{IN} and V_{OUT} of ≥ 1 V
- (4) Typical value applies for T_A = 25°C, maximum value applies for T_A = 70°C with T_J ≤ 125°C, PCB layout needs to support proper thermal performance.
- (5) Typical value applies for T_A = 25°C, maximum value applies for T_A = 85°C with T_J ≤ 125°C, PCB layout needs to support proper thermal performance.

ELECTRICAL CHARACTERISTICS

$V_{IN} = 3.6V$, $V_{OUT} = 1.8V$, $EN = V_{IN}$, $MODE = GND$, $T_A = -40^{\circ}C$ to $85^{\circ}C$ ⁽¹⁾ typical values are at $T_A = 25^{\circ}C$ (unless otherwise noted), $C_{IN} = 2.2\mu F$, $L = 2.2\mu H$, $C_{OUT} = 4.7\mu F$, see parameter measurement information

PARAMETER		TEST CONDITIONS	MIN	TYP	MAX	UNIT	
SUPPLY							
V_{IN}	Input voltage range ⁽²⁾		2.05		6	V	
I_Q	Operating quiescent current	$I_{OUT} = 0mA$. PFM mode enabled (Mode = 0) device not switching		22	40	μA	
		$I_{OUT} = 0mA$. PFM mode enabled (Mode = 0) device switching, $V_{IN} = 3.6V$, $V_{OUT} = 1.2V$		25		μA	
		$I_{OUT} = 0mA$. Switching with no load (MODE/DATA = V_{IN}), PWM operation, $V_{OUT} = 1.8V$, $L = 2.2\mu H$		3		mA	
I_{SD}	Shutdown current	$EN = GND$ ⁽³⁾		0.1	1	μA	
UVLO	Undervoltage lockout threshold	Falling		1.8	1.9	V	
		Rising		1.9	2.05	V	
ENABLE, MODE THRESHOLD							
$V_{IH\ TH}$	Threshold for detecting high EN, MODE	$2.05V \leq V_{IN} \leq 6V$, rising edge		0.8	1	V	
$V_{IL\ TH\ HYS}$	Threshold for detecting low EN, MODE	$2.05V \leq V_{IN} \leq 6V$, falling edge	0.4	0.6		V	
I_{IN}	Input bias Current, EN, MODE	$EN, MODE = GND$ or $V_{IN} = 3.6V$		0.01	0.5	μA	
POWER SWITCH							
$R_{DS(ON)}$	High side MOSFET on-resistance	$V_{IN} = 3.6V$, $T_{Jmax} = 85^{\circ}C$; $R_{DS(ON)}$ max value		600	850	m Ω	
	Low Side MOSFET on-resistance			350	480		
I_{LIMF}	Forward current limit MOSFET high-side	$V_{IN} = 3.6V$, open loop		690	850	1050	mA
	Forward current limit MOSFET low side			550	840	1220	mA
T_{SD}	Thermal shutdown	Increasing junction temperature		150		$^{\circ}C$	
	Thermal shutdown hysteresis	Decreasing junction temperature		20		$^{\circ}C$	
CONTROLLER							
t_{ONmin}	Minimum ON time	$V_{IN} 3.6V$, $V_{OUT} = 1.8V$, Mode = high, $I_{OUT} = 0mA$		135		ns	
t_{OFFmin}	Minimum OFF time			40		ns	
OUTPUT							
V_{REF}	Internal Reference Voltage			0.70		V	
V_{OUT}	Output voltage accuracy ⁽⁴⁾	$V_{IN} = 3.6V$, Mode = GND, device operating in PFM Mode, $I_{OUT} = 0mA$		0%			
		$V_{IN} = 3.6V$, MODE = V_{IN} , $I_{OUT} = 0mA$	$T_A = 25^{\circ}C$	-2.0%	2.0%		
			$T_A = -40^{\circ}C$ to $85^{\circ}C$	-2.5%	2.5%		
	DC output voltage load regulation	PWM operation, Mode = $V_{IN} = 3.6V$, $V_{OUT} = 1.8V$		0.001		%/mA	
DC output voltage line regulation	$I_{OUT} = 0mA$, Mode = V_{IN} , $2.05V \leq V_{IN} \leq 6V$		0		%/V		
t_{Start}	Start-up Time	Time from active EN to $V_{OUT} = 1.8V$, $V_{IN} = 3.6V$, 10 Ω load		100		μs	
I_{LK_SW}	Leakage current into SW pin	$V_{IN} = V_{OUT} = V_{SW} = 3.6V$, $EN = GND$ ⁽⁵⁾		0.1	0.5	μA	

- (1) In applications where high power dissipation and/or poor package thermal resistance is present, the maximum ambient temperature may have to be derated. Maximum ambient temperature ($T_{A(max)}$) is dependent on the maximum operating junction temperature ($T_{J(max)}$), the maximum power dissipation of the device in the application ($P_{D(max)}$), and the junction-to-ambient thermal resistance of the part/package in the application (θ_{JA}), as given by the following equation: $T_{A(max)} = T_{J(max)} - (\theta_{JA} \times P_{D(max)})$.
- (2) The minimum required supply voltage for startup is 2.05V. The part is functional down to the falling UVL (Under Voltage Lockout) threshold
- (3) Shutdown current into VIN pin, includes internal leakage
- (4) $V_{IN} = V_O + 1.0V$
- (5) The internal resistor divider network is disconnected from FB pin.

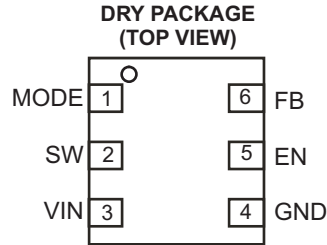

PIN FUNCTIONS

PIN		I/O	DESCRIPTION
NAME	NO		
VIN	3	PWR	V _{IN} power supply pin.
GND	4	PWR	GND supply pin
EN	5	IN	This is the enable pin of the device. Pulling this pin to low forces the device into shutdown mode. Pulling this pin to high enables the device. This pin must be terminated.
SW	2	OUT	This is the switch pin and is connected to the internal MOSFET switches. Connect the inductor to this terminal
FB	6	IN	Feedback Pin for the internal regulation loop. Connect this pin directly to the output capacitor.
MODE	1	IN	MODE pin = high forces the device to operate in PWM mode. Mode = low enables the Power Save Mode with automatic transition from PFM (Pulse frequency mode) to PWM (pulse width modulation) mode.

FUNCTIONAL BLOCK DIAGRAM

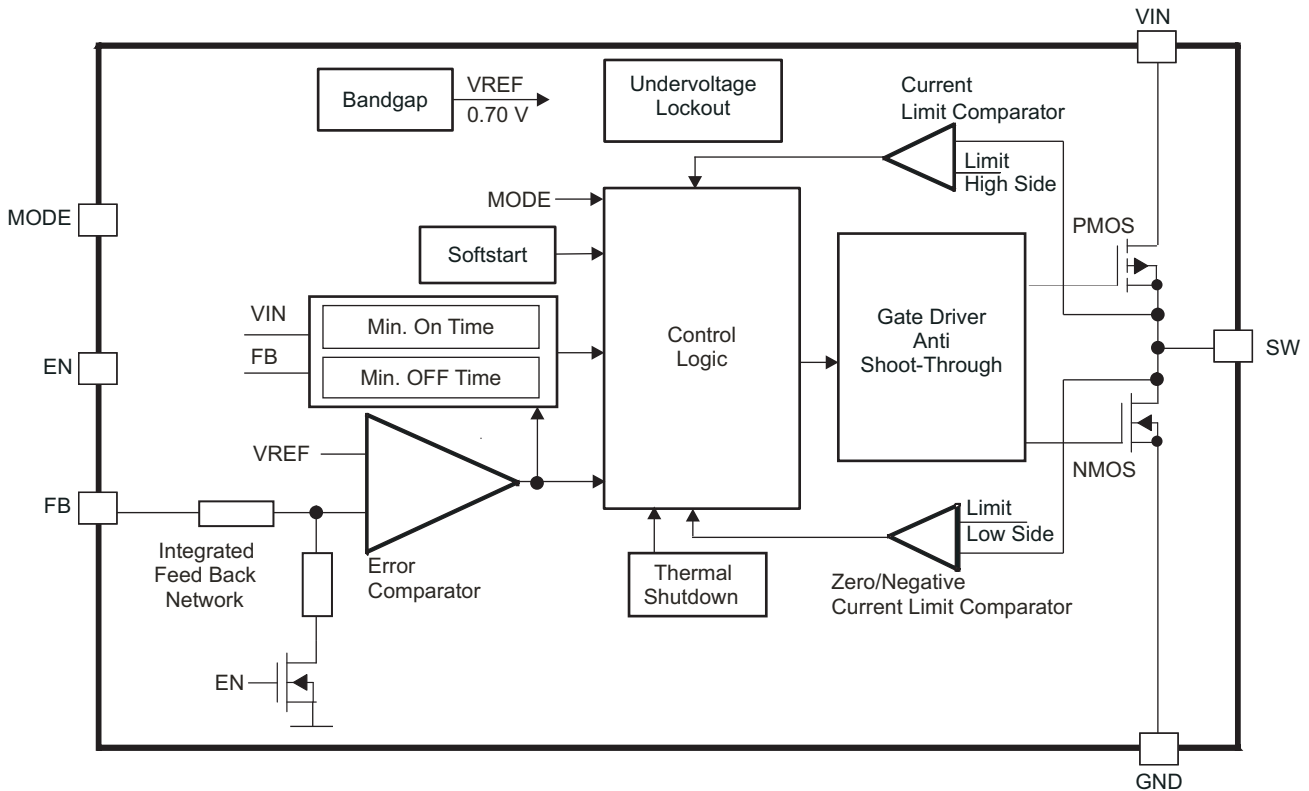

PARAMETER MEASUREMENT INFORMATION

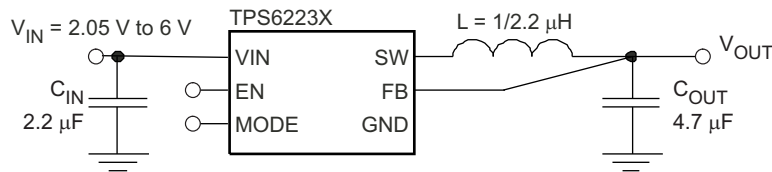

C_{IN} : Murata GRM155R60J225ME15D 2.2 μ F 0402 size

C_{OUT} : Murata GRM188R60J475ME 4.7 μ F 0603 size, $V_{OUT} \geq 1.8$ V

C_{OUT} : Taiyo Yuden AMK105BJ475MV 4.7 μ F 0402 size, $V_{OUT} = 1.2$ V

L: Murata LQM2HPN1R0MJ0 1 μ H, LQM2HPN2R2MJ0 2.2 μ H,
size 2.5x2.0x1.2mm³

TYPICAL CHARACTERISTICS

Table of Graphs

			FIGURE
η	Efficiency	vs Load current	1, 2, 3, 4, 5, 6, 7
η	Efficiency	vs Output Current	8, 9, 10, 11
V_O	Output voltage	vs Output current	12, 13, 14, 15, 16, 17
	Switching frequency	vs Output current	18, 19, 20, 21, 22, 23, 24, 25, 26, 27
	Output voltage peak to peak	vs Output current	28,29
I_Q	Quiescent current	vs Ambient temperature	30
I_{SD}	Shutdown current	vs Ambient temperature	31
$r_{DS(ON)}$	PMOS Static drain-source on-state resistance	vs Supply voltage and ambient temperature	32
	NMOS Static drain-source on-state resistance	vs Supply voltage and ambient temperature	33
PSRR	Power supply rejection ratio	vs Frequency	34
	Typical operation		35, 36, 37
	Line transient response	PFM	38
		PWM	39
	Mode transition PFM / forced PWM		40
	AC - load regulation performance		41 42, 43
	Load transient response		44, 45, 46, 47
	Start-up		48, 49
	Spurious Output Noise, 12R Load		50
	Spurious Output Noise, 100R Load		51

TYPICAL CHARACTERISTICS (continued)

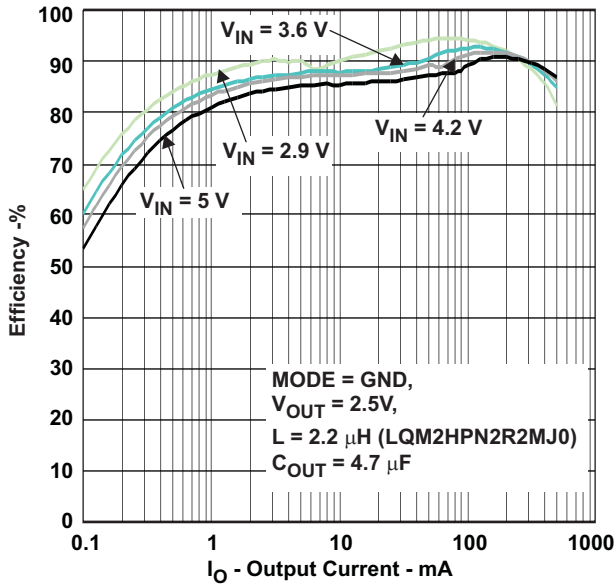

Figure 1. Efficiency PFM/PWM Mode 2.5V Output Voltage

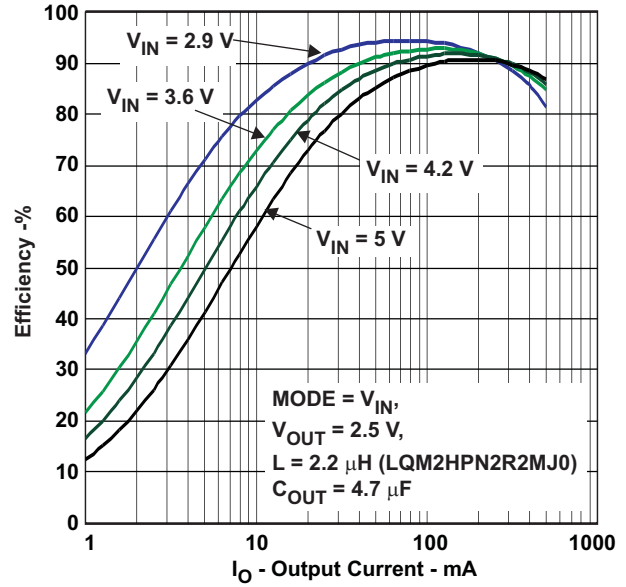

Figure 2. Efficiency Forced PWM Mode 2.5V Output Voltage

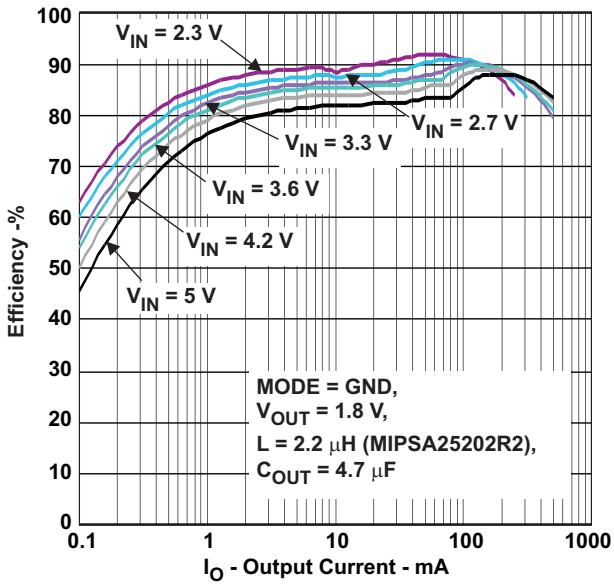

Figure 3. Efficiency PFM/PWM MODE 1.8V Output Voltage

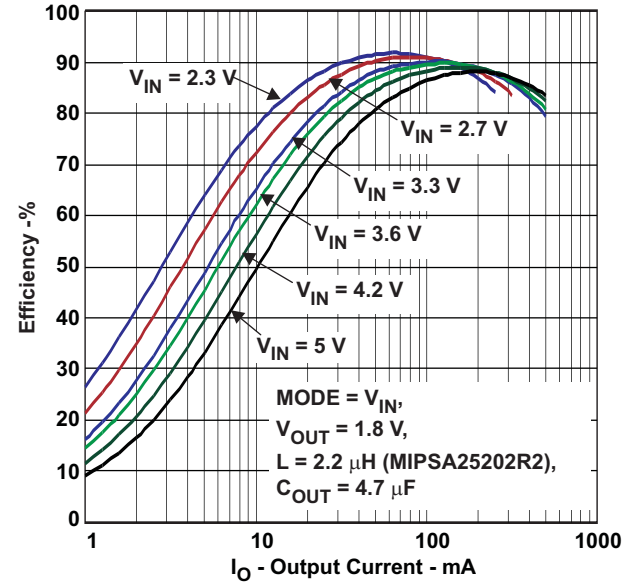

Figure 4. Efficiency Forced PWM Mode 1.8V Output Voltage

TYPICAL CHARACTERISTICS (continued)

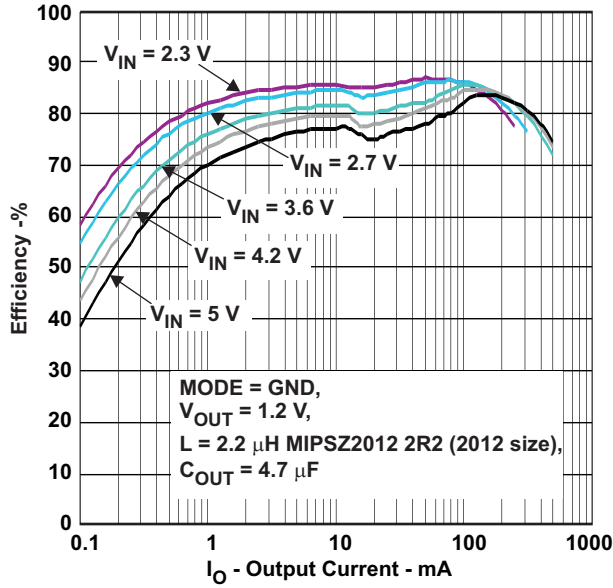

Figure 5. Efficiency PFM/PWM Mode 1.2V Output voltage

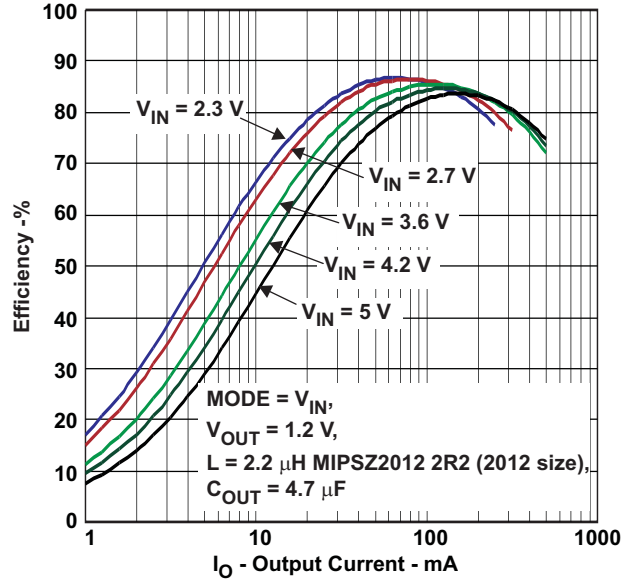

Figure 6. Efficiency Forced PWM Mode 1.2V Output Voltage

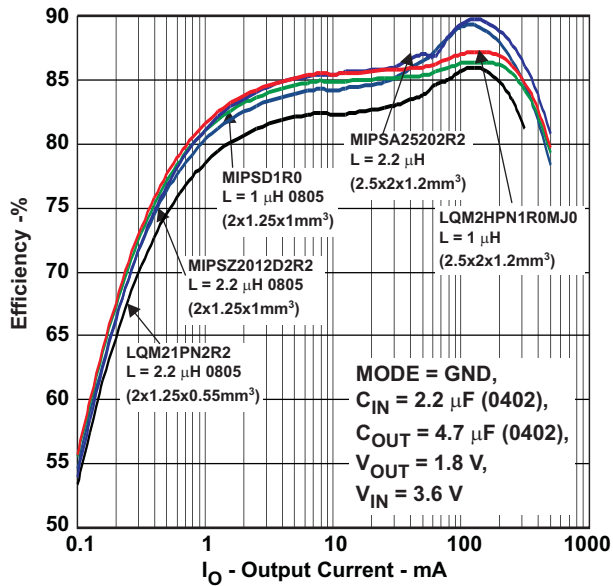

Figure 7. Comparison Efficiency vs Inductor Value and Size

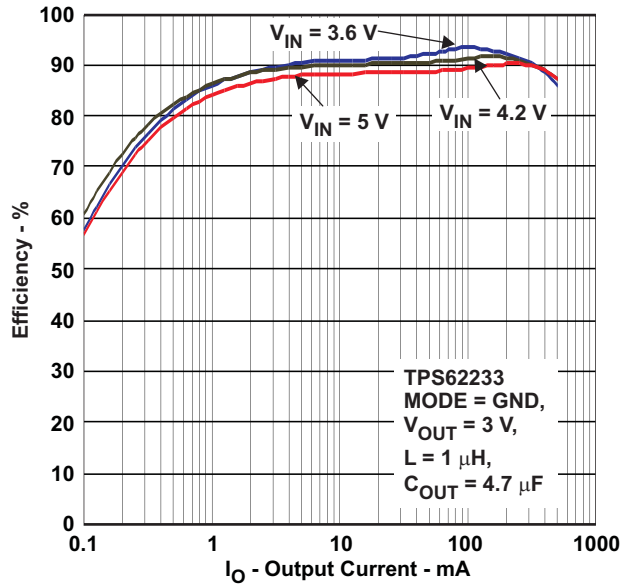

Figure 8. Comparison Efficiency vs I_{OUT} – TPS62233

TYPICAL CHARACTERISTICS (continued)

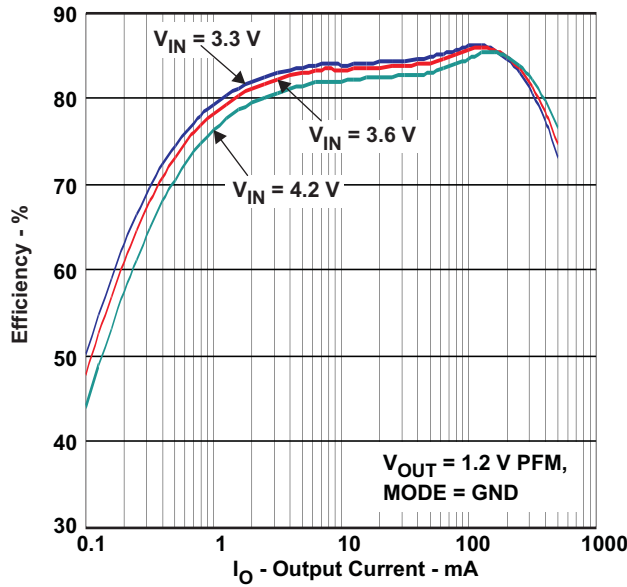

Figure 9. Comparison Efficiency vs IOUT – TPS62235

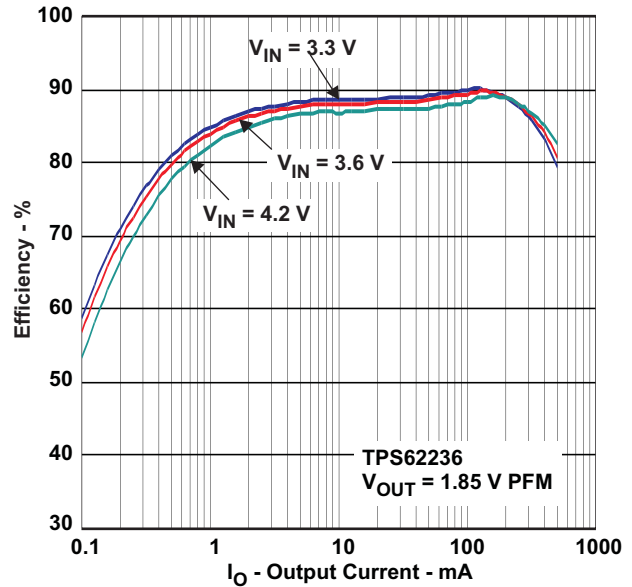

Figure 10. Comparison Efficiency vs IOUT – TPS62236

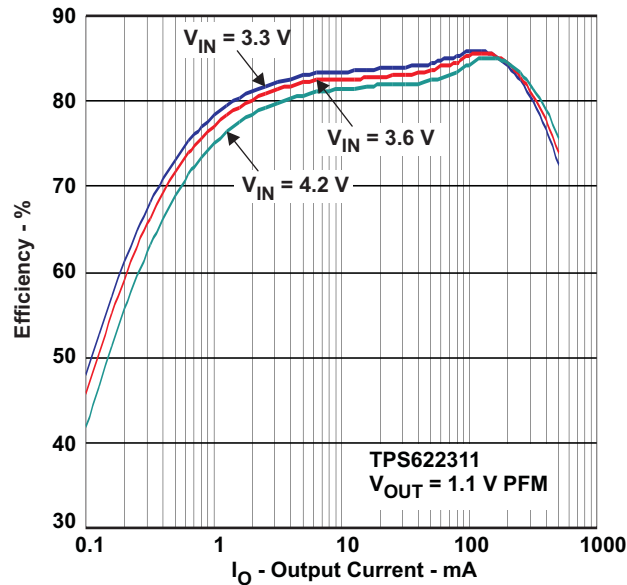

Figure 11. Comparison Efficiency vs IOUT – TPS622311

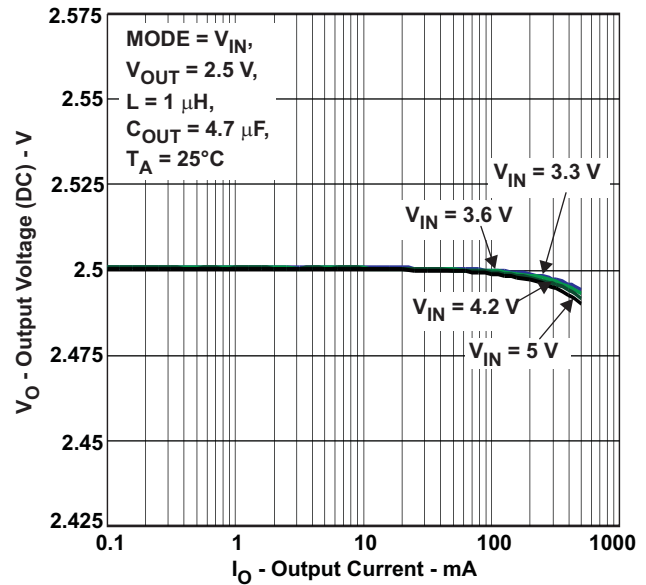

Figure 12. 2.5V Output Voltage Accuracy forced PWM Mode

TYPICAL CHARACTERISTICS (continued)

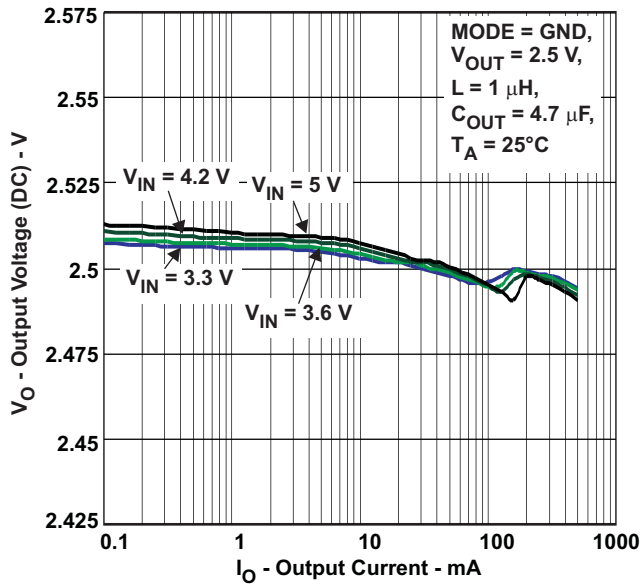

Figure 13. 2.5V Output Voltage Accuracy PFM/PWM Mode

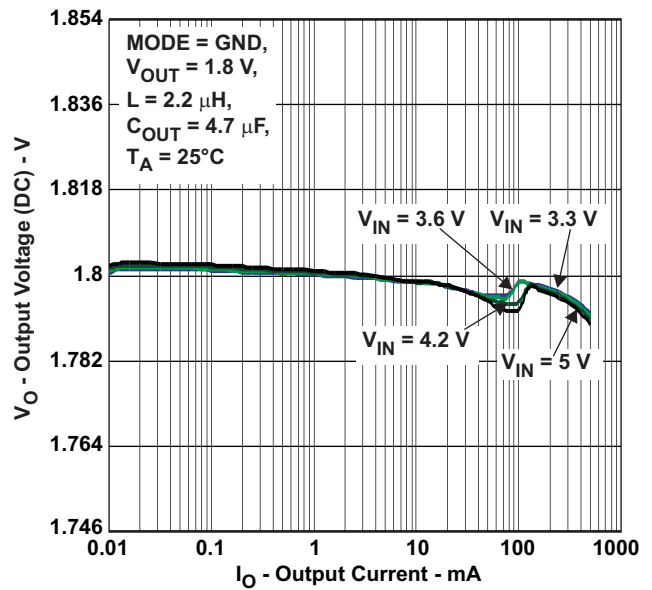

Figure 14. 1.8V Output Voltage Accuracy PFM/PWM Mode

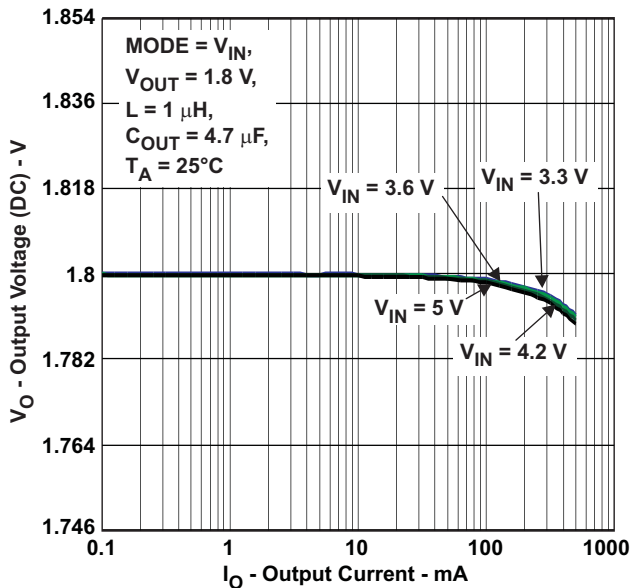

Figure 15. 1.8V Output Voltage Accuracy Forced PWM MODE

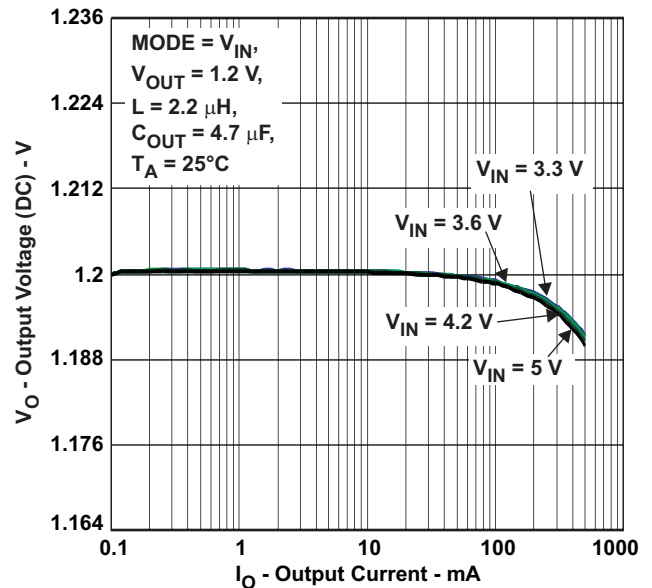

Figure 16. 1.2V Output Voltage Accuracy Forced PWM MODE

TYPICAL CHARACTERISTICS (continued)

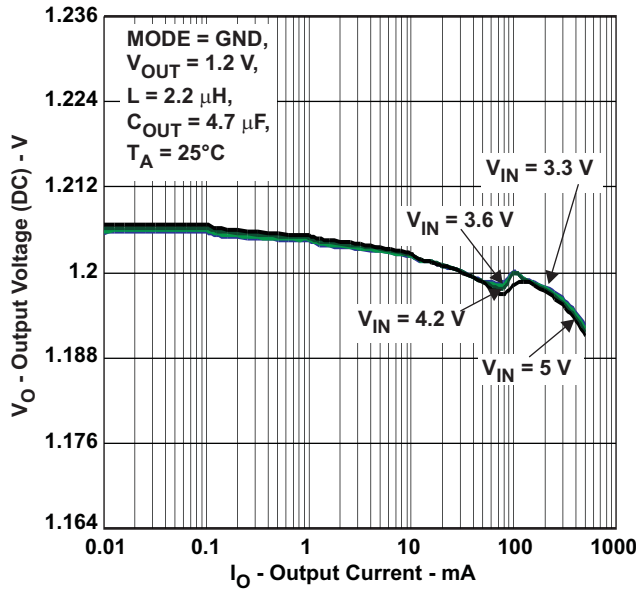

Figure 17. 1.2V Output Voltage Accuracy PFM/PWM MODE

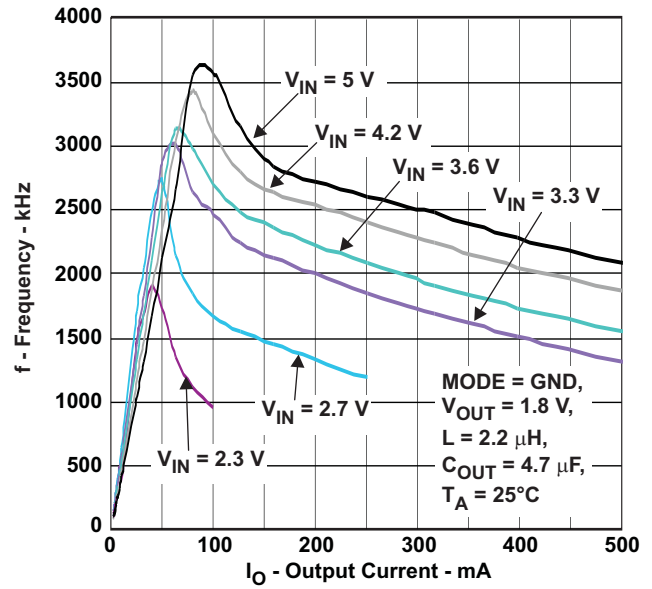

Figure 18. Switching Frequency vs Output Current, 1.8V Output Voltage MODE = GND

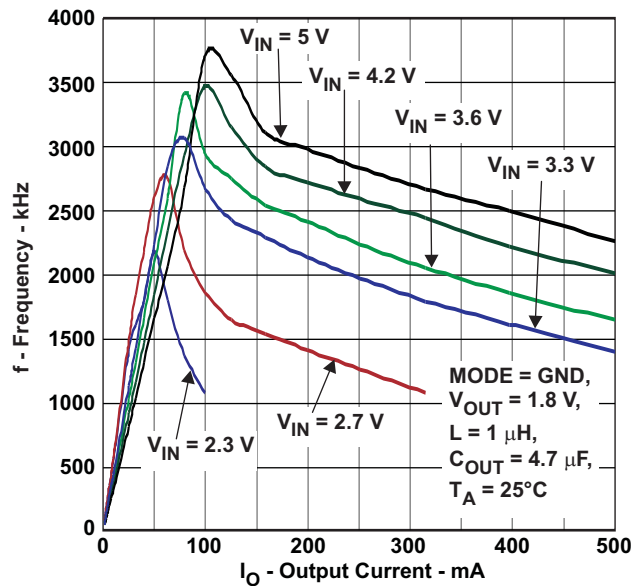

Figure 19. Switching Frequency vs Output Current, 1.8V Output Voltage MODE = GND

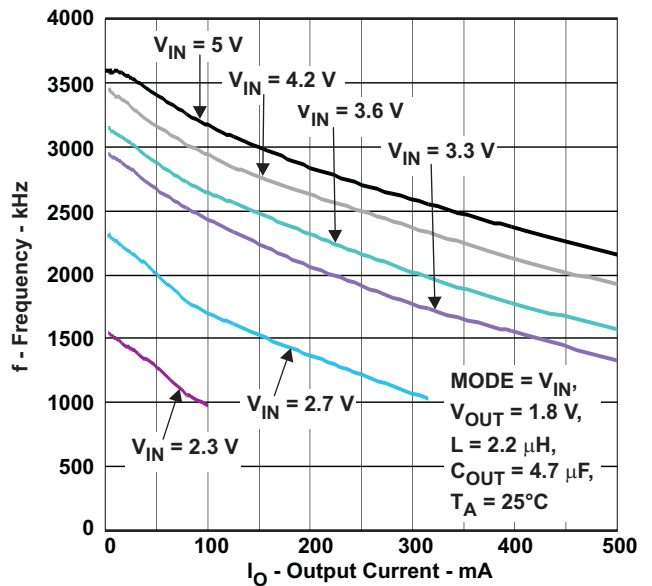

Figure 20. Switching Frequency vs Output Current, 1.8V Output Voltage MODE = VIN

TYPICAL CHARACTERISTICS (continued)

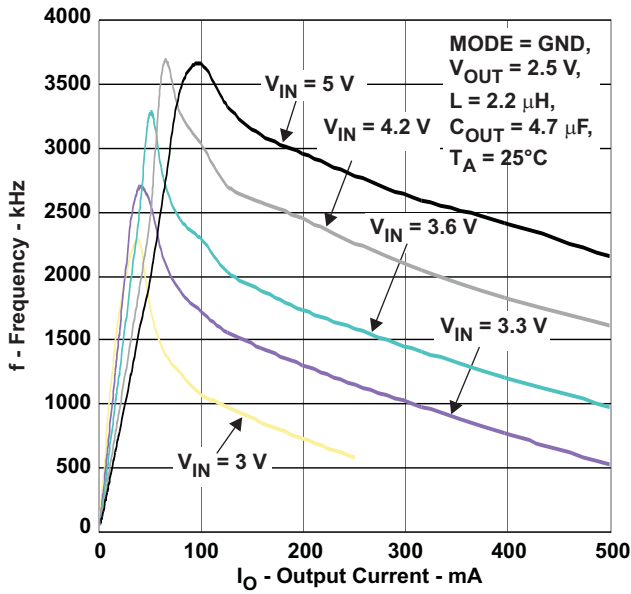

Figure 21. Switching Frequency vs Output Current, 2.5V Output Voltage MODE = GND

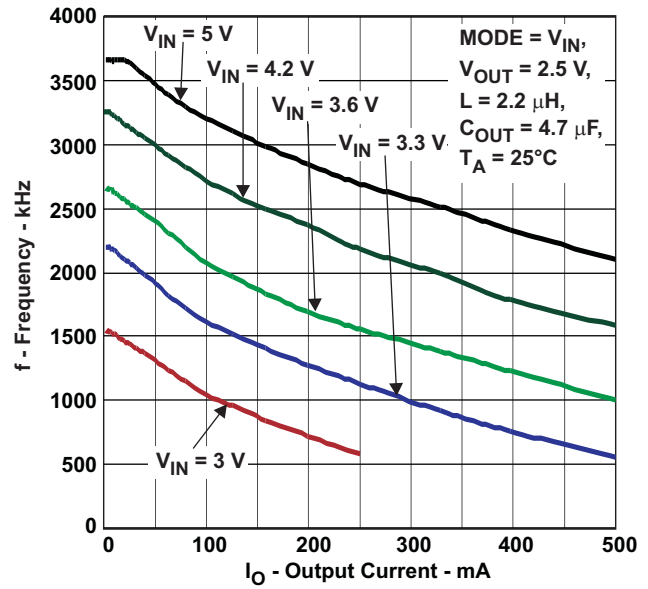

Figure 22. Switching Frequency vs Output Current, 2.5V Output Voltage MODE = VIN

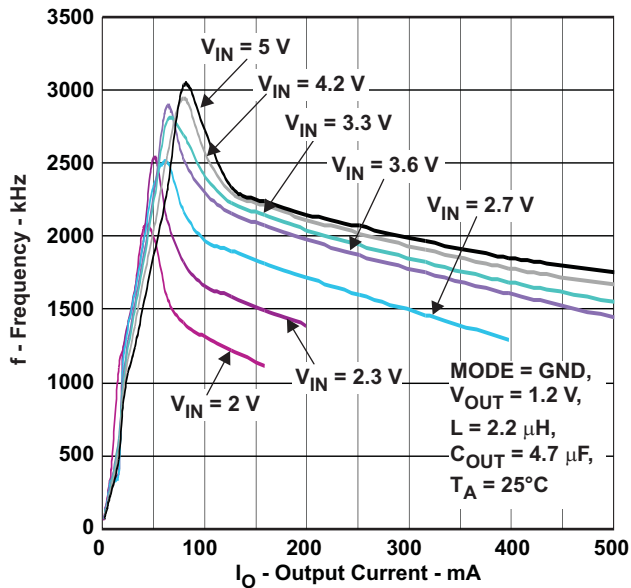

Figure 23. Switching Frequency vs Output Current, 1.2V Output Voltage MODE = GND

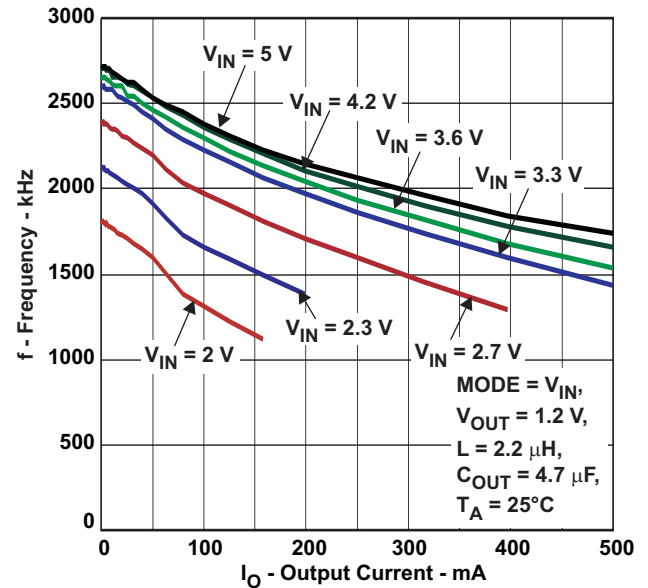

Figure 24. Switching Frequency vs Output Current, 1.2V Output Voltage MODE = VIN

TYPICAL CHARACTERISTICS (continued)

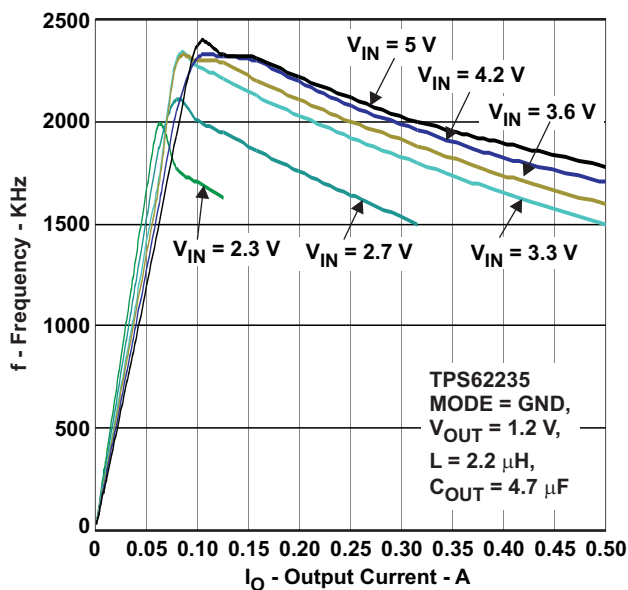

Figure 25. Switching Frequency vs Output Current, 1.2V Output Voltage MODE = PFM – TPS62235

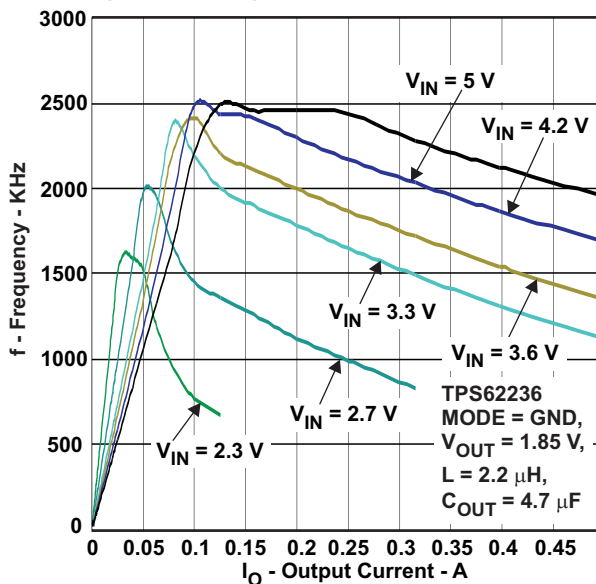

Figure 26. Switching Frequency vs Output Current, 1.85V Output Voltage MODE = PFM – TPS62236

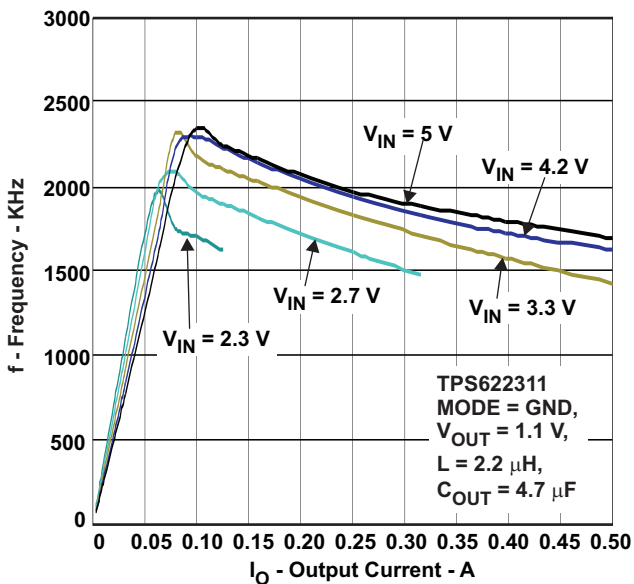

Figure 27. Switching Frequency vs Output Current, 1.1V Output Voltage MODE = PFM – TPS622311

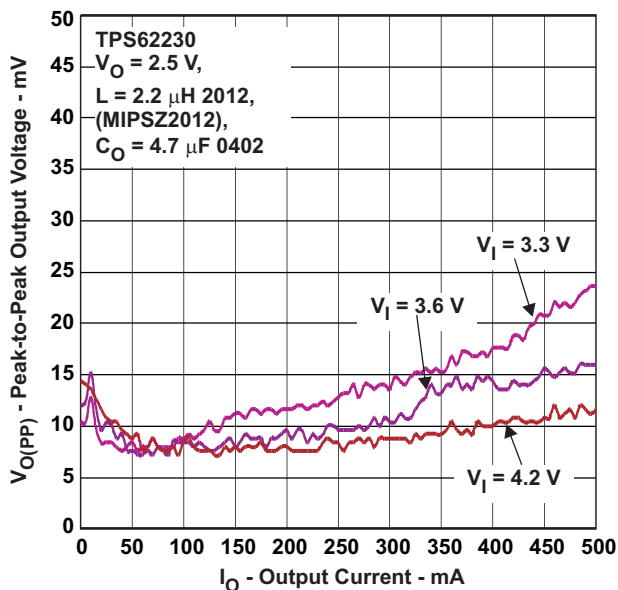

Figure 28. Output Voltage, Peak-to-Peak vs Output Current – TPS62230

TYPICAL CHARACTERISTICS (continued)

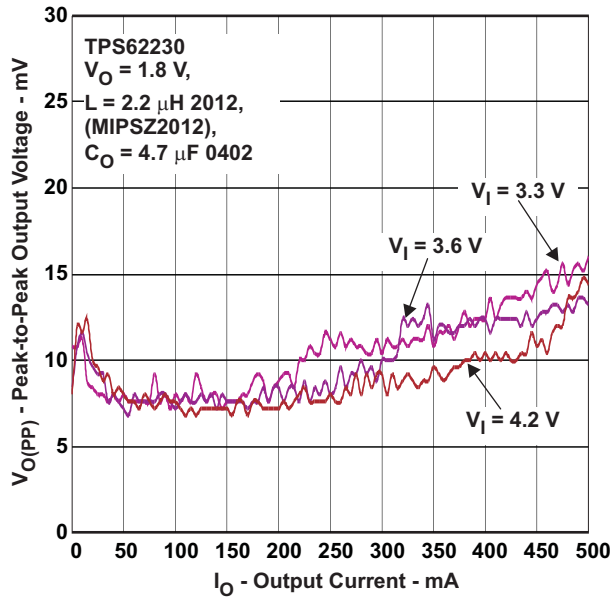

Figure 29. Output Voltage, Peak-to-Peak vs Output Current – TPS62231

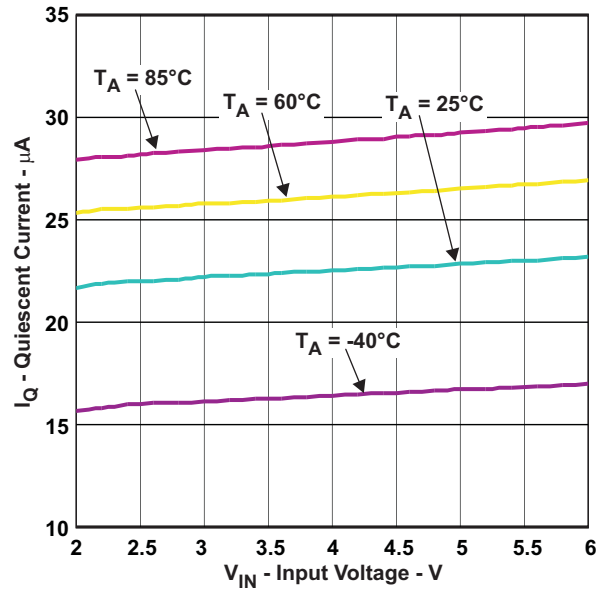

Figure 30. Quiescent Current I_Q vs Ambient Temperature T_A

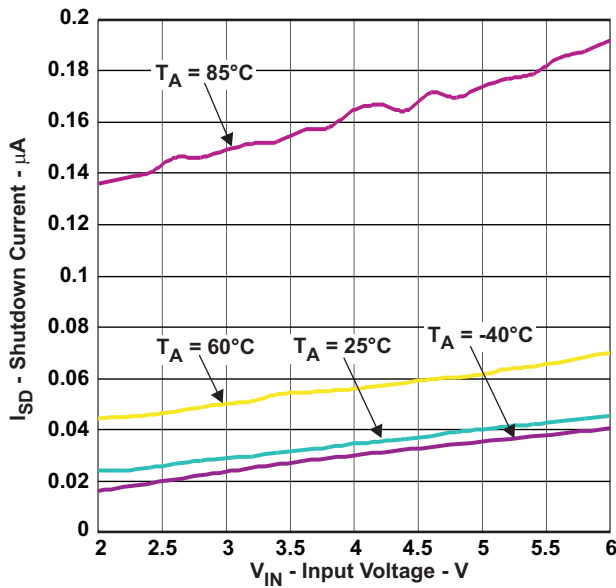

Figure 31. Shutdown Current I_{SD} vs Ambient Temperature T_A

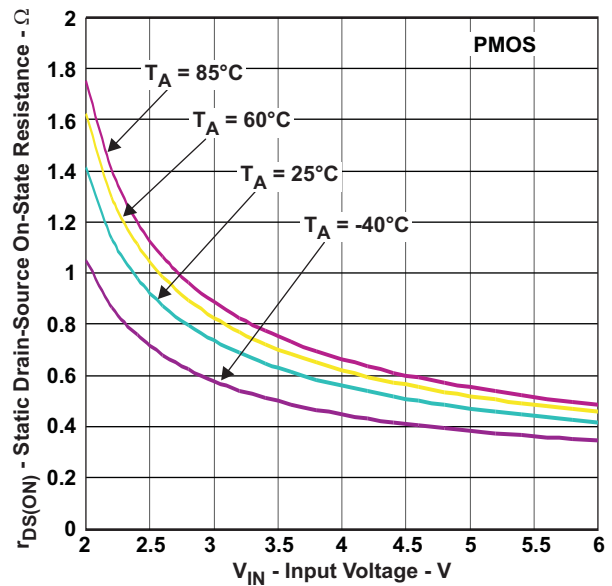

Figure 32. PMOS $R_{DS(ON)}$ vs Supply Voltage V_{IN} and Ambient Temperature T_A

TYPICAL CHARACTERISTICS (continued)

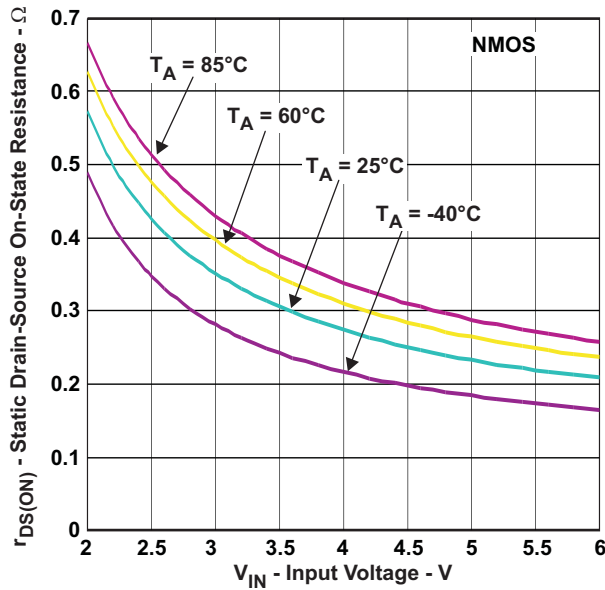

Figure 33. NMOS $R_{DS(ON)}$ vs Supply Voltage V_{IN} and Ambient Temperature T_A

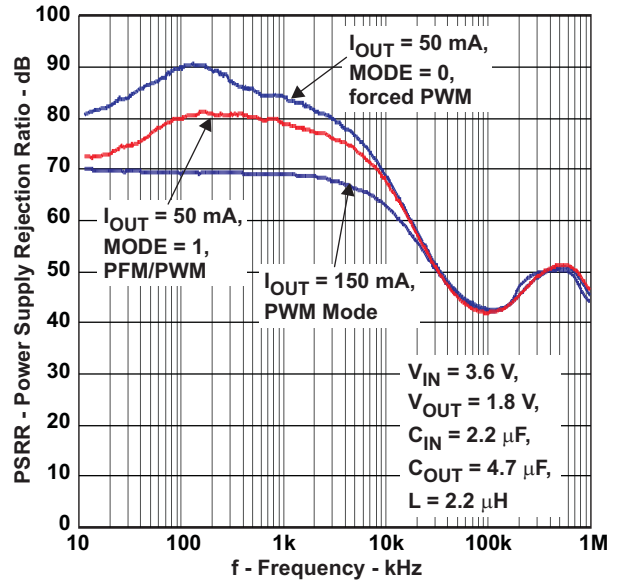

Figure 34. TPS62231 1.8V PSRR

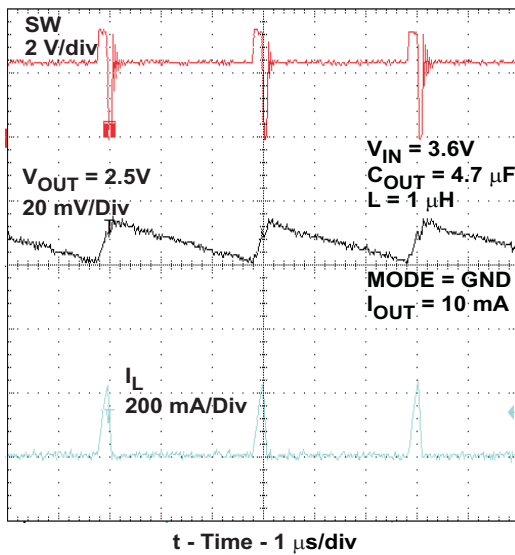

Figure 35. PFM Mode Operation $I_{OUT} = 10\text{mA}$

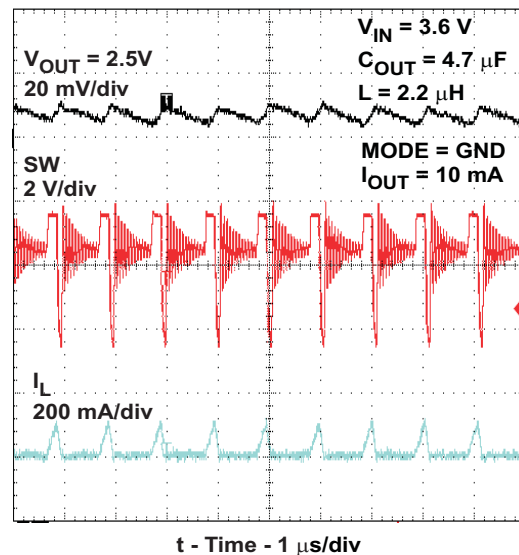
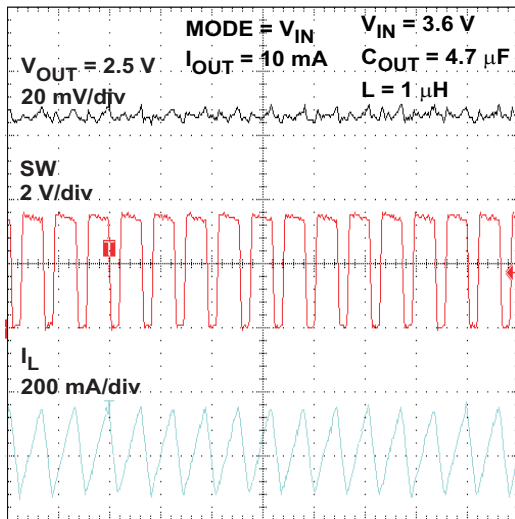

Figure 36. PFM Mode Operation $I_{OUT} = 10\text{mA}$

TYPICAL CHARACTERISTICS (continued)



t - Time - 500 ns/div

Figure 37. Forced PWM Mode Operation $I_{OUT} = 10\text{mA}$

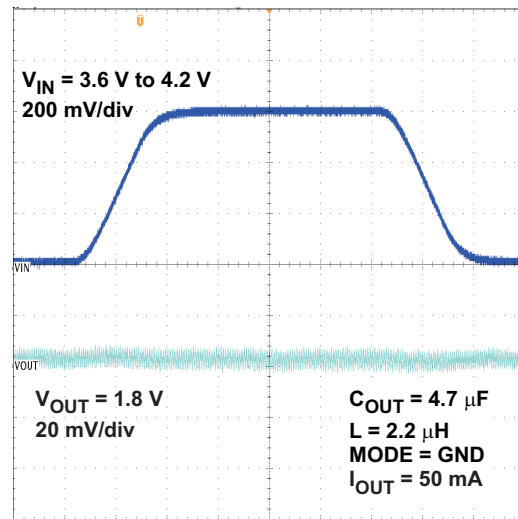

t - Time - 10 μs/div

Figure 38. Line Transient Response PFM Mode

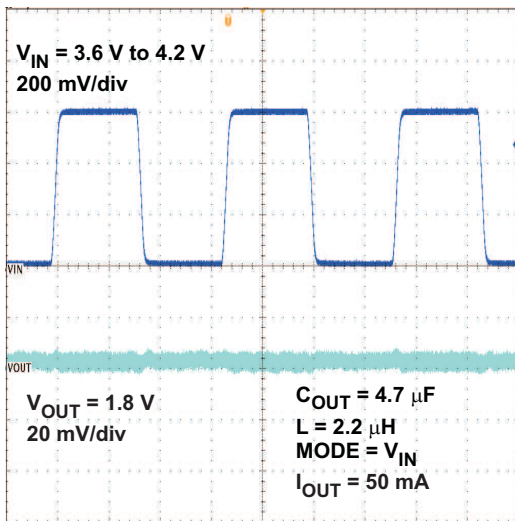

t - Time - 100 μs/div

Figure 39. Line Transient Response PWM Mode

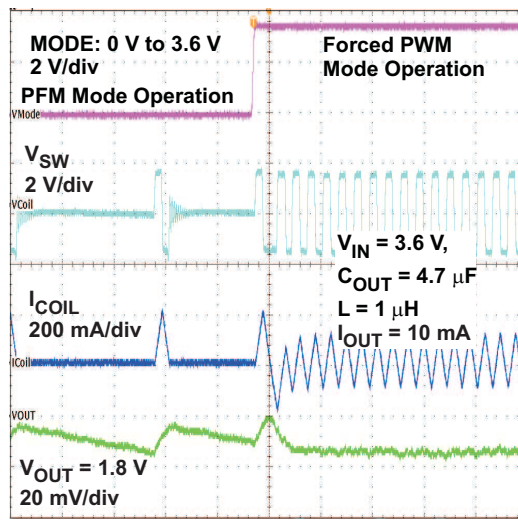

t - Time - 1 μs/div

Figure 40. Mode Transition PFM / Forced PWM Mode

TYPICAL CHARACTERISTICS (continued)

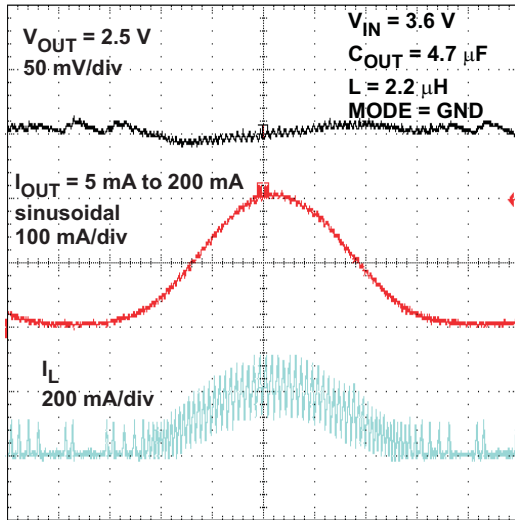

Figure 41. AC – Load Regulation Performance 2.5V V_{OUT} PFM Mode

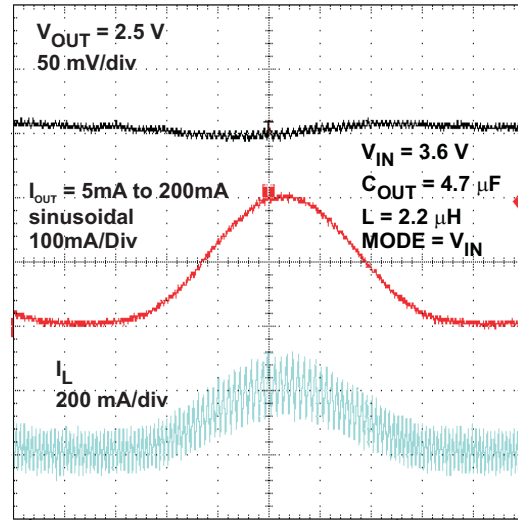

Figure 42. AC – Load Regulation Performance 2.5V V_{OUT} PWM Mode

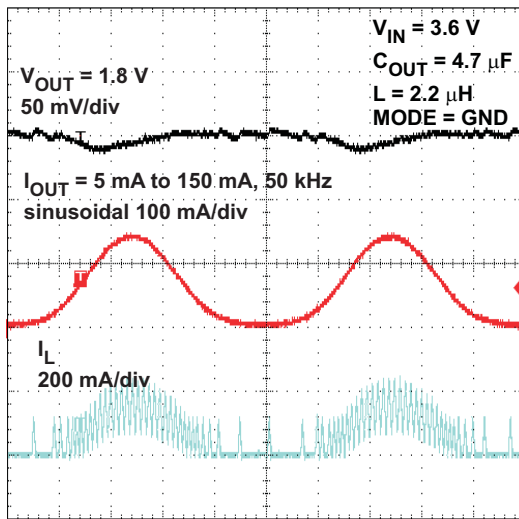

Figure 43. AC – Load Regulation Performance 1.8V V_{OUT} PFM Mode

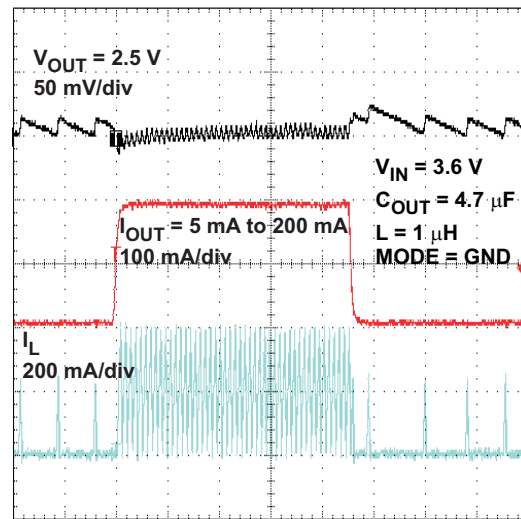
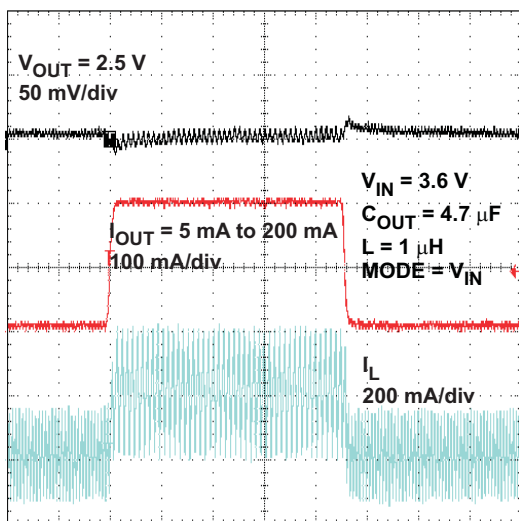

Figure 44. Load Transient Response 5mA to 200mA PFM to PWM Mode, V_{OUT} 2.5V

TYPICAL CHARACTERISTICS (continued)



t - Time - 5 μ s/div

Figure 45. Load Transient Response 5mA to 200mA, Forced PWM Mode, V_{OUT} 2.5V

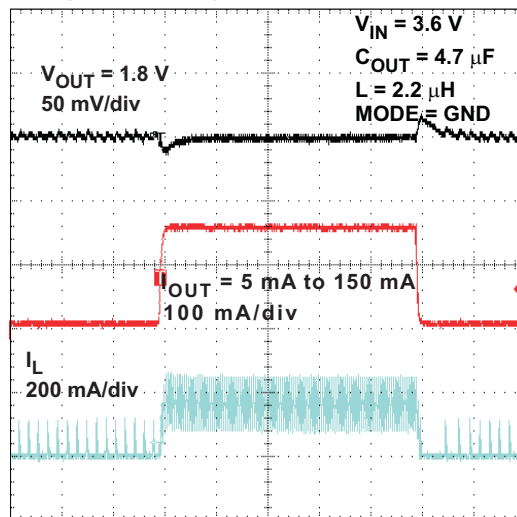

t - Time - 10 μ s/div

Figure 46. Load Transient Response 5mA to 150mA, PFM to PWM Mode, V_{OUT} 1.8V

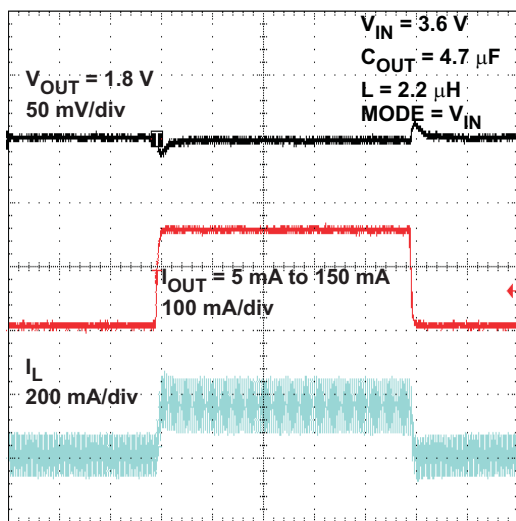

t - Time - 10 μ s/div

Figure 47. Load Transient Response 5mA to 150mA, Forced PWM Mode, V_{OUT} 1.8V

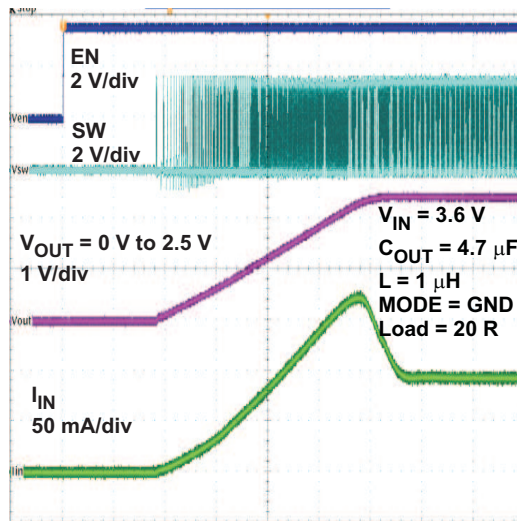

t - Time - 20 μ s/div

Figure 48. Start Up into 20 Ω Load, V_{OUT} 2.5V

TYPICAL CHARACTERISTICS (continued)

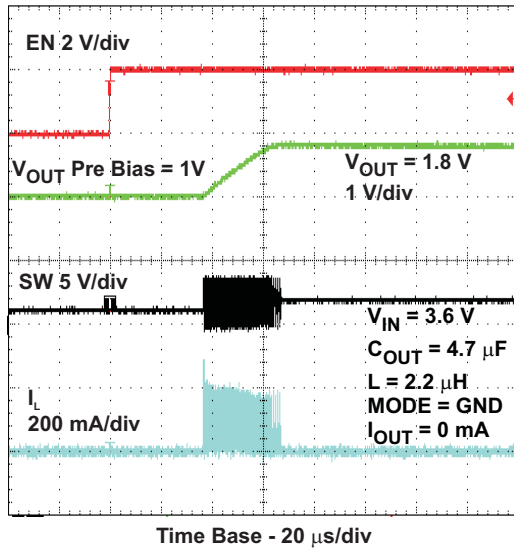

Figure 49. Startup in 1V Pre-biased Output

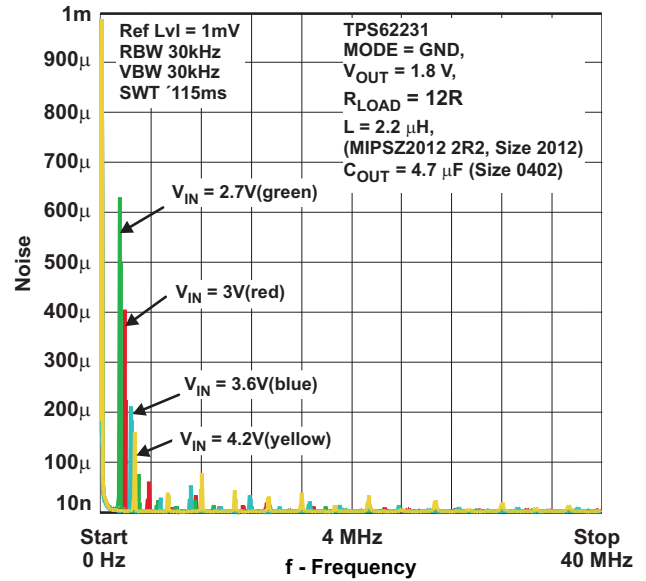

Figure 50. Spurious Output Noise, 12R Load, TPS62231

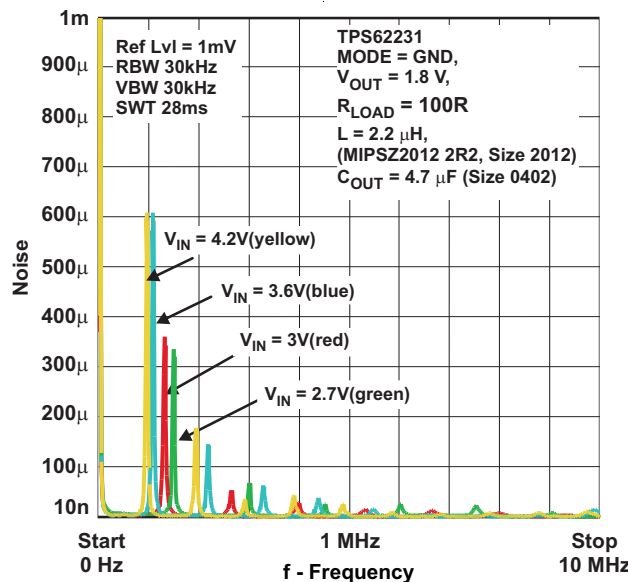

Figure 51. Spurious Output Noise, 100R Load, TPS62231

DETAILED DESCRIPTION

The TPS6223X synchronous step down converter family includes a unique hysteretic PWM controller scheme which enables switch frequencies over 3MHz, excellent transient and AC load regulation as well as operation with cost competitive external components.

The controller topology supports forced PWM Mode as well as Power Save Mode operation. Power Save Mode operation reduces the quiescent current consumption down to 22µA and ensures high conversion efficiency at light loads by skipping switch pulses. In forced PWM Mode, the device operates on a quasi fixed frequency, avoids pulse skipping, and allows filtering of the switch noise by external filter components.

The TPS6223X devices offer fixed output voltage options featuring smallest solution size by using only three external components.

The internal switch current limit of typical 850mA supports output currents of up to 500mA, depending on the operating condition.

A significant advantage of TPS6223X compared to other hysteretic PWM controller topologies is its excellent DC and AC load regulation capability in combination with low output voltage ripple over the entire load range which makes this part well suited for audio and RF applications.

OPERATION

Once the output voltage falls below the threshold of the error comparator, a switch pulse is initiated, and the high side switch is turned on. It remains turned on until a minimum on time of t_{ONmin} expires and the output voltage trips the threshold of the error comparator or the inductor current reaches the high side switch current limit. Once the high side switch turns off, the low side switch rectifier is turned on and the inductor current ramps down until the high side switch turns on again or the inductor current reaches zero.

In forced PWM Mode operation, negative inductor current is allowed to enable continuous conduction mode even at no load condition.

POWER SAVE MODE

Connecting the MODE pin to GND enables the automatic PWM and power-save mode operation. The converter operates in quasi fixed frequency PWM mode at moderate to heavy loads and in the PFM (Pulse Frequency Modulation) mode during light loads, which maintains high efficiency over a wide load current range. In PFM Mode, the device starts to skip switch pulses and generates only single pulses with an on time of t_{ONmin} . The PFM Mode frequency depends on the load current and the external inductor and output capacitor values. The PFM Mode of TPS6223X is optimized for low output voltage ripple if small external components are used. Even at low output currents, the PFM frequency is above the audible noise spectrum and makes this operation mode suitable for audio applications.

The on time t_{ONmin} can be estimated to:

$$t_{ONmin} = \frac{V_{OUT}}{V_{IN}} \times 260 \text{ ns} \quad (1)$$

Therefore, the peak inductor current in PFM mode is approximately:

$$I_{L_{PFMpeak}} = \frac{(V_{IN} - V_{OUT})}{L} \times t_{ONmin} \quad (2)$$

The transition from PFM into PWM mode and vice versa can be estimated to:

$$I_{OUT_PFM/PWM} = 0.5 \times I_{L_{PFMpeak}} \quad (3)$$

With

t_{ON} : High side switch on time [ns]

V_{IN} : Input voltage [V]

V_{OUT} : Output voltage [V]

L : Inductance [µH]

$I_{L_{PFMpeak}}$: PFM inductor peak current [mA]

$I_{OUT_PFM/PWM}$: Output current for PFM to PWM mode transition and vice versa [mA]

FORCED PWM MODE

Pulling the MODE pin high forces the converter to operate in a continuous conduction PWM mode even at light load currents. The advantage is that the converter operates with a quasi fixed frequency that allows simple filtering of the switching frequency for noise-sensitive applications. In this mode, the efficiency is lower compared to the power-save mode during light loads.

For additional flexibility, it is possible to switch from power-save mode to forced PWM mode during operation. This allows efficient power management by adjusting the operation of the converter to the specific system requirements.

100% DUTY CYCLE LOW DROPOUT OPERATION

The device starts to enter 100% duty cycle mode once the input voltage comes close to the nominal output voltage. In order to maintain the output voltage, the High Side switch is turned on 100% for one or more cycles.

With further decreasing V_{IN} the High Side MOSFET switch is turned on completely. In this case the converter offers a low input-to-output voltage difference. This is particularly useful in battery-powered applications to achieve longest operation time by taking full advantage of the whole battery voltage range.

The minimum input voltage to maintain regulation depends on the load current and output voltage, and can be calculated as:

$$V_{INmin} = V_{OUTmax} + I_{OUTmax} \times (R_{DS(on)max} + R_L) \quad (4)$$

With:

I_{OUTmax} = maximum output current plus inductor ripple current

$R_{DS(on)max}$ = maximum P-channel switch R_{DSon} .

R_L = DC resistance of the inductor

V_{OUTmax} = nominal output voltage plus maximum output voltage tolerance

UNDER VOLTAGE LOCKOUT

The under voltage lockout circuit prevents the device from misoperation at low input voltages. It prevents the converter from turning on the switch or rectifier MOSFET under undefined conditions. The TPS6223X devices have a UVLO threshold set to 1.8V (typical). Fully functional operation is permitted for input voltage down to the falling UVLO threshold level. The converter starts operation again once the input voltage trips the rising UVLO threshold level.

SOFT START

The TPS6223X has an internal soft-start circuit that controls the ramp up of the output voltage and limits the inrush current during start-up. This limits input voltage drops when a battery or a high-impedance power source is connected to the input of the converter.

The soft-start system generates a monotonic ramp up of the output voltage and reaches the nominal output voltage typically 100 μ s after EN pin was pulled high.

Should the output voltage not have reached its target value by this time, such as in the case of heavy load, the converter then operates in a current limit mode set by its switch current limits.

TPS6223X is able to start into a pre-biased output capacitor. The converter starts with the applied bias voltage and ramps the output voltage to its nominal value.

ENABLE / SHUTDOWN

The device starts operation when EN is set high and starts up with the soft start as previously described. For proper operation, the EN pin must be terminated and must not be left floating.

Pulling the EN pin low forces the device into shutdown, with a shutdown quiescent current of typically 0.1 μ A. In this mode, the P and N-channel MOSFETs are turned off, the internal resistor feedback divider is disconnected, and the entire internal-control circuitry is switched off.

The EN input can be used to control power sequencing in a system with various DC/DC converters. The EN pin can be connected to the output of another converter, to drive the EN pin high and getting a sequencing of supply rails.

SHORT-CIRCUIT PROTECTION

The TPS6223X integrates a High Side and Low Side MOSFET current limit to protect the device against heavy load or short circuit. The current in the switches is monitored by current limit comparators. When the current in the P-channel MOSFET reaches its current limit, the P-channel MOSFET is turned off and the N-channel MOSFET is turned on to ramp down the current in the inductor. The High Side MOSFET switch can only turn on again, once the current in the Low Side MOSFET switch has decreased below the threshold of its current limit comparator.

THERMAL SHUTDOWN

As soon as the junction temperature, T_J , exceeds 150°C (typical) the device goes into thermal shutdown. In this mode, the High Side and Low Side MOSFETs are turned-off. The device continues its operation when the junction temperature falls below the thermal shutdown hysteresis.

APPLICATION INFORMATION

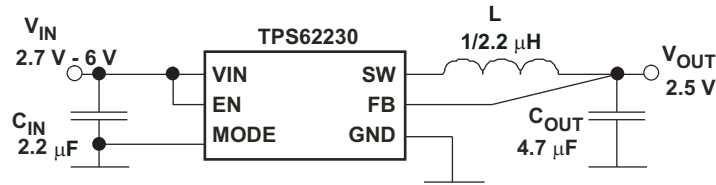

Figure 52. TPS62230 2.5V Output

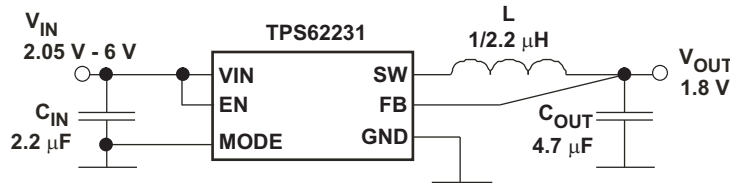

Figure 53. TPS62231 1.8V Output

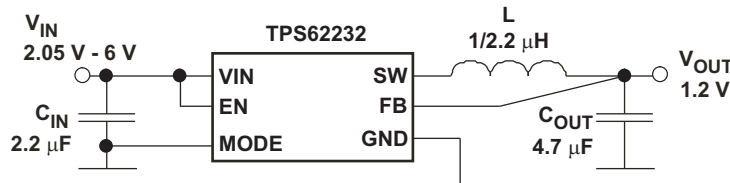

Figure 54. TPS62232 1.2V Output

OUTPUT FILTER DESIGN (INDUCTOR AND OUTPUT CAPACITOR)

The TPS6223X is optimized to operate with effective inductance values in the range of 0.7μH to 4.3μH and with effective output capacitance in the range of 2.0μF to 15μF. The internal compensation is optimized to operate with an output filter of $L = 1.0\mu\text{H}/2.2\mu\text{H}$ and $C_{\text{OUT}} = 4.7\mu\text{F}$. Larger or smaller inductor/capacitor values can be used to optimize the performance of the device for specific operation conditions. For more details, see the *CHECKING LOOP STABILITY* section.

INDUCTOR SELECTION

The inductor value affects its peak-to-peak ripple current, the PWM-to-PFM transition point, the output voltage ripple and the efficiency. The selected inductor has to be rated for its dc resistance and saturation current. The inductor ripple current (ΔI_L) decreases with higher inductance and increases with higher V_{IN} or V_{OUT} . Equation 5 calculates the maximum inductor current under static load conditions. The saturation current of the inductor should be rated higher than the maximum inductor current as calculated with Equation 6. This is recommended because during heavy load transient the inductor current will rise above the calculated value.

$$\Delta I_L = V_{\text{out}} \times \frac{1 - \frac{V_{\text{out}}}{V_{\text{in}}}}{L \times f} \quad (5)$$

$$I_{L_{\text{max}}} = I_{\text{outmax}} + \frac{\Delta I_L}{2} \quad (6)$$

With:

f = Switching Frequency

L = Inductor Value

ΔI_L = Peak to Peak inductor ripple current

$I_{L_{\text{max}}}$ = Maximum Inductor current

In high-frequency converter applications, the efficiency is essentially affected by the inductor AC resistance (i.e., quality factor) and to a smaller extent by the inductor DCR value. To achieve high efficiency operation, care should be taken in selecting inductors featuring a quality factor above 25 at the switching frequency. Increasing the inductor value produces lower RMS currents, but degrades transient response. For a given physical inductor size, increased inductance usually results in an inductor with lower saturation current.

The total losses of the coil consist of both the losses in the DC resistance, $R_{(DC)}$, and the following frequency-dependent components:

- The losses in the core material (magnetic hysteresis loss, especially at high switching frequencies)
- Additional losses in the conductor from the skin effect (current displacement at high frequencies)
- Magnetic field losses of the neighboring windings (proximity effect)
- Radiation losses

The following inductor series from different suppliers have been used with the TPS6223X converters.

Table 1. List of inductors

INDUCTANCE [μ H]	DIMENSIONS [mm3]	INDUCTOR TYPE	SUPPLIER
1.0/2.2	2.5 × 2.0 × 1.2	LQM2HPN1R0MJ0	Murata
2.2	2.0 × 1.2 × 0.55	LQM21PN2R2	Murata
1.0/2.2	2.0 × 1.2 × 1.0	MIPSZ2012	FDK
1.0/2.2	2.0 × 2.5 × 1.2	MIPSA2520	FDK
1.0/2.2	2.0 × 1.2 × 1.0	KSLI2012 series	Hitachi Metal

OUTPUT CAPACITOR SELECTION

The unique hysteretic PWM control scheme of the TPS62230 allows the use of tiny ceramic capacitors. Ceramic capacitors with low ESR values have the lowest output voltage ripple and are recommended. The output capacitor requires either an X7R or X5R dielectric. Y5V and Z5U dielectric capacitors, aside from their wide variation in capacitance over temperature, become resistive at high frequencies.

At light load currents the converter operate in Power Save Mode and the output voltage ripple is dependent on the output capacitor value and the PFM peak inductor current. Higher output capacitor values minimize the voltage ripple in PFM Mode and tighten DC output accuracy in PFM Mode.

INPUT CAPACITOR SELECTION

Because of the nature of the buck converter having a pulsating input current, a low ESR input capacitor is required for best input voltage filtering and minimizing the interference with other circuits caused by high input voltage spikes. For most applications a 2.2 μ F to 4.7 μ F ceramic capacitor is recommended. The input capacitor can be increased without any limit for better input voltage filtering. Because ceramic capacitor loses up to 80% of its initial capacitance at 5V, it is recommended to use 4.7 μ F input capacitors for input voltages > 4.5V.

Take care when using only small ceramic input capacitors. When a ceramic capacitor is used at the input and the power is being supplied through long wires, such as from a wall adapter, a load step at the output or V_{IN} step on the input can induce ringing at the VIN pin. This ringing can couple to the output and be mistaken as loop instability or could even damage the part by exceeding the maximum ratings.

Table 2 shows a list of tested input/output capacitors.

Table 2. List of Capacitor

CAPACITANCE [μ F]	SIZE	CAPACITOR TYPE	SUPPLIER
2.2	0402	GRM155R60J225	Murata
4.7	0402	AMK105BJ475MV	Taiyo Yuden
4.7	0402	GRM155R60J475	Murata
4.7	0402	CL05A475MQ5NRNC	Samsung
4.7	0603	GRM188R60J475	Murata

CHECKING LOOP STABILITY

The first step of circuit and stability evaluation is to look from a steady-state perspective at the following signals:

- Switching node, SW
- Inductor current, I_L
- Output ripple voltage, $V_{OUT(AC)}$

These are the basic signals that need to be measured when evaluating a switching converter. When the switching waveform shows large duty cycle jitter or the output voltage or inductor current shows oscillations, the regulation loop may be unstable. This is often a result of board layout and/or L-C combination.

As a next step in the evaluation of the regulation loop, the load transient response is tested. The time between the application of the load transient and the turn on of the P-channel MOSFET, the output capacitor must supply all of the current required by the load. V_{OUT} immediately shifts by an amount equal to $\Delta I_{(LOAD)} \times ESR$, where ESR is the effective series resistance of C_{OUT} . $\Delta I_{(LOAD)}$ begins to charge or discharge C_O generating a feedback error signal used by the regulator to return V_{OUT} to its steady-state value. The results are most easily interpreted when the device operates in PWM mode.

During this recovery time, V_{OUT} can be monitored for settling time, overshoot or ringing that helps judge the converter's stability. Without any ringing, the loop has usually more than 45° of phase margin.

Because the damping factor of the circuitry is directly related to several resistive parameters (e.g., MOSFET $r_{DS(on)}$) that are temperature dependant, the loop stability analysis has to be done over the input voltage range, load current range, and temperature range.

LAYOUT CONSIDERATIONS

As for all switching power supplies, the layout is an important step in the design. Proper function of the device demands careful attention to PCB layout. Care must be taken in board layout to get the specified performance. If the layout is not carefully done, the regulator could show poor line and/or load regulation, stability issues as well as EMI problems. It is critical to provide a low inductance, impedance ground path. Therefore, use wide and short traces for the main current paths. The input capacitor should be placed as close as possible to the IC pins as well as the inductor and output capacitor.

Use a common Power GND node and a different node for the Signal GND to minimize the effects of ground noise. Keep the common path to the GND PIN, which returns the small signal components and the high current of the output capacitors as short as possible to avoid ground noise. The FB line should be connected to the output capacitor and routed away from noisy components and traces (e.g. SW line).

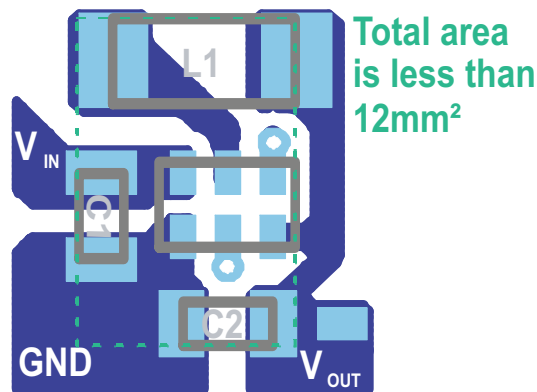

Figure 55. Recommended PCB Layout for TPS6223X

PACKAGING INFORMATION

Orderable Device	Status ⁽¹⁾	Package Type	Package Drawing	Pins	Package Qty	Eco Plan ⁽²⁾	Lead/ Ball Finish	MSL Peak Temp ⁽³⁾	Samples (Requires Login)
TPS62230DRYR	ACTIVE	SON	DRY	6	5000	Green (RoHS & no Sb/Br)	CU NIPDAU	Level-1-260C-UNLIM	
TPS62230DRYT	ACTIVE	SON	DRY	6	250	Green (RoHS & no Sb/Br)	CU NIPDAU	Level-1-260C-UNLIM	
TPS622310DRYR	ACTIVE	SON	DRY	6	5000	Green (RoHS & no Sb/Br)	CU NIPDAU	Level-1-260C-UNLIM	
TPS622310DRYT	ACTIVE	SON	DRY	6	250	Green (RoHS & no Sb/Br)	CU NIPDAU	Level-1-260C-UNLIM	
TPS622311DRYR	ACTIVE	SON	DRY	6	5000	Green (RoHS & no Sb/Br)	CU NIPDAU	Level-1-260C-UNLIM	
TPS622311DRYT	ACTIVE	SON	DRY	6	250	Green (RoHS & no Sb/Br)	CU NIPDAU	Level-1-260C-UNLIM	
TPS622312DRYR	ACTIVE	SON	DRY	6	5000	Green (RoHS & no Sb/Br)	CU NIPDAU	Level-1-260C-UNLIM	
TPS622312DRYT	ACTIVE	SON	DRY	6	250	Green (RoHS & no Sb/Br)	CU NIPDAU	Level-1-260C-UNLIM	
TPS622313DRYR	ACTIVE	SON	DRY	6	5000	Green (RoHS & no Sb/Br)	CU NIPDAU	Level-1-260C-UNLIM	
TPS622313DRYT	ACTIVE	SON	DRY	6	250	Green (RoHS & no Sb/Br)	CU NIPDAU	Level-1-260C-UNLIM	
TPS622314DRYR	ACTIVE	SON	DRY	6	5000	Green (RoHS & no Sb/Br)	CU NIPDAU	Level-1-260C-UNLIM	
TPS622314DRYT	ACTIVE	SON	DRY	6	250	Green (RoHS & no Sb/Br)	CU NIPDAU	Level-1-260C-UNLIM	
TPS622315DRYR	ACTIVE	SON	DRY	6	5000	Green (RoHS & no Sb/Br)	CU NIPDAU	Level-1-260C-UNLIM	
TPS622315DRYT	ACTIVE	SON	DRY	6	250	Green (RoHS & no Sb/Br)	CU NIPDAU	Level-1-260C-UNLIM	
TPS622316DRYR	ACTIVE	SON	DRY	6	5000	Green (RoHS & no Sb/Br)	CU NIPDAU	Level-1-260C-UNLIM	
TPS622316DRYT	ACTIVE	SON	DRY	6	250	Green (RoHS & no Sb/Br)	CU NIPDAU	Level-1-260C-UNLIM	
TPS622317DRYR	ACTIVE	SON	DRY	6	5000	Green (RoHS & no Sb/Br)	CU NIPDAU	Level-1-260C-UNLIM	

Orderable Device	Status ⁽¹⁾	Package Type	Package Drawing	Pins	Package Qty	Eco Plan ⁽²⁾	Lead/ Ball Finish	MSL Peak Temp ⁽³⁾	Samples (Requires Login)
TPS622317DRYT	ACTIVE	SON	DRY	6	250	Green (RoHS & no Sb/Br)	CU NIPDAU	Level-1-260C-UNLIM	
TPS622318DRYR	ACTIVE	SON	DRY	6	5000	Green (RoHS & no Sb/Br)	CU NIPDAU	Level-1-260C-UNLIM	
TPS622318DRYT	ACTIVE	SON	DRY	6	250	Green (RoHS & no Sb/Br)	CU NIPDAU	Level-1-260C-UNLIM	
TPS62231DRYR	ACTIVE	SON	DRY	6	5000	Green (RoHS & no Sb/Br)	CU NIPDAU	Level-1-260C-UNLIM	
TPS62231DRYT	ACTIVE	SON	DRY	6	250	Green (RoHS & no Sb/Br)	CU NIPDAU	Level-1-260C-UNLIM	
TPS62232DRYR	ACTIVE	SON	DRY	6	5000	Green (RoHS & no Sb/Br)	CU NIPDAU	Level-1-260C-UNLIM	
TPS62232DRYT	ACTIVE	SON	DRY	6	250	TBD	Call TI	Call TI	
TPS62233DRYR	ACTIVE	SON	DRY	6	5000	Green (RoHS & no Sb/Br)	CU NIPDAU	Level-1-260C-UNLIM	
TPS62233DRYT	ACTIVE	SON	DRY	6	250	Green (RoHS & no Sb/Br)	CU NIPDAU	Level-1-260C-UNLIM	
TPS62234DRYR	ACTIVE	SON	DRY	6	5000	Green (RoHS & no Sb/Br)	CU NIPDAU	Level-1-260C-UNLIM	
TPS62234DRYT	ACTIVE	SON	DRY	6	250	Green (RoHS & no Sb/Br)	CU NIPDAU	Level-1-260C-UNLIM	
TPS62235DRYR	ACTIVE	SON	DRY	6	5000	Green (RoHS & no Sb/Br)	CU NIPDAU	Level-1-260C-UNLIM	
TPS62235DRYT	ACTIVE	SON	DRY	6	250	Green (RoHS & no Sb/Br)	CU NIPDAU	Level-1-260C-UNLIM	
TPS62236DRYR	ACTIVE	SON	DRY	6	5000	Green (RoHS & no Sb/Br)	CU NIPDAU	Level-1-260C-UNLIM	
TPS62236DRYT	ACTIVE	SON	DRY	6	250	Green (RoHS & no Sb/Br)	CU NIPDAU	Level-1-260C-UNLIM	
TPS62237DRYR	ACTIVE	SON	DRY	6	5000	Green (RoHS & no Sb/Br)	CU NIPDAU	Level-1-260C-UNLIM	
TPS62237DRYT	ACTIVE	SON	DRY	6	250	Green (RoHS & no Sb/Br)	CU NIPDAU	Level-1-260C-UNLIM	
TPS62238DRYR	ACTIVE	SON	DRY	6	5000	Green (RoHS & no Sb/Br)	CU NIPDAU	Level-1-260C-UNLIM	

Orderable Device	Status ⁽¹⁾	Package Type	Package Drawing	Pins	Package Qty	Eco Plan ⁽²⁾	Lead/ Ball Finish	MSL Peak Temp ⁽³⁾	Samples (Requires Login)
TPS62238DRYT	ACTIVE	SON	DRY	6	250	Green (RoHS & no Sb/Br)	CU NIPDAU	Level-1-260C-UNLIM	
TPS62239DRYR	ACTIVE	SON	DRY	6	5000	Green (RoHS & no Sb/Br)	CU NIPDAU	Level-1-260C-UNLIM	
TPS62239DRYT	ACTIVE	SON	DRY	6	250	Green (RoHS & no Sb/Br)	CU NIPDAU	Level-1-260C-UNLIM	

⁽¹⁾ The marketing status values are defined as follows:

ACTIVE: Product device recommended for new designs.

LIFEBUY: TI has announced that the device will be discontinued, and a lifetime-buy period is in effect.

NRND: Not recommended for new designs. Device is in production to support existing customers, but TI does not recommend using this part in a new design.

PREVIEW: Device has been announced but is not in production. Samples may or may not be available.

OBSOLETE: TI has discontinued the production of the device.

⁽²⁾ Eco Plan - The planned eco-friendly classification: Pb-Free (RoHS), Pb-Free (RoHS Exempt), or Green (RoHS & no Sb/Br) - please check <http://www.ti.com/productcontent> for the latest availability information and additional product content details.

TBD: The Pb-Free/Green conversion plan has not been defined.

Pb-Free (RoHS): TI's terms "Lead-Free" or "Pb-Free" mean semiconductor products that are compatible with the current RoHS requirements for all 6 substances, including the requirement that lead not exceed 0.1% by weight in homogeneous materials. Where designed to be soldered at high temperatures, TI Pb-Free products are suitable for use in specified lead-free processes.

Pb-Free (RoHS Exempt): This component has a RoHS exemption for either 1) lead-based flip-chip solder bumps used between the die and package, or 2) lead-based die adhesive used between the die and leadframe. The component is otherwise considered Pb-Free (RoHS compatible) as defined above.

Green (RoHS & no Sb/Br): TI defines "Green" to mean Pb-Free (RoHS compatible), and free of Bromine (Br) and Antimony (Sb) based flame retardants (Br or Sb do not exceed 0.1% by weight in homogeneous material)

⁽³⁾ MSL, Peak Temp. -- The Moisture Sensitivity Level rating according to the JEDEC industry standard classifications, and peak solder temperature.

Important Information and Disclaimer: The information provided on this page represents TI's knowledge and belief as of the date that it is provided. TI bases its knowledge and belief on information provided by third parties, and makes no representation or warranty as to the accuracy of such information. Efforts are underway to better integrate information from third parties. TI has taken and continues to take reasonable steps to provide representative and accurate information but may not have conducted destructive testing or chemical analysis on incoming materials and chemicals. TI and TI suppliers consider certain information to be proprietary, and thus CAS numbers and other limited information may not be available for release.

In no event shall TI's liability arising out of such information exceed the total purchase price of the TI part(s) at issue in this document sold by TI to Customer on an annual basis.

TAPE AND REEL INFORMATION

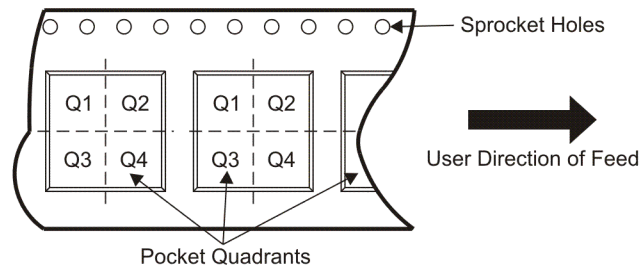
QUADRANT ASSIGNMENTS FOR PIN 1 ORIENTATION IN TAPE

*All dimensions are nominal

Device	Package Type	Package Drawing	Pins	SPQ	Reel Diameter (mm)	Reel Width W1 (mm)	A0 (mm)	B0 (mm)	K0 (mm)	P1 (mm)	W (mm)	Pin1 Quadrant
TPS62230DRYR	SON	DRY	6	5000	179.0	8.4	1.2	1.65	0.7	4.0	8.0	Q1
TPS62230DRYT	SON	DRY	6	250	179.0	8.4	1.2	1.65	0.7	4.0	8.0	Q1
TPS622310DRYR	SON	DRY	6	5000	179.0	8.4	1.2	1.65	0.7	4.0	8.0	Q1
TPS622310DRYT	SON	DRY	6	250	179.0	8.4	1.2	1.65	0.7	4.0	8.0	Q1
TPS622311DRYR	SON	DRY	6	5000	179.0	8.4	1.2	1.65	0.7	4.0	8.0	Q1
TPS622311DRYT	SON	DRY	6	250	179.0	8.4	1.2	1.65	0.7	4.0	8.0	Q1
TPS622312DRYR	SON	DRY	6	5000	179.0	8.4	1.2	1.65	0.7	4.0	8.0	Q1
TPS622312DRYT	SON	DRY	6	250	179.0	8.4	1.2	1.65	0.7	4.0	8.0	Q1
TPS622313DRYR	SON	DRY	6	5000	179.0	8.4	1.2	1.65	0.7	4.0	8.0	Q1
TPS622313DRYT	SON	DRY	6	250	179.0	8.4	1.2	1.65	0.7	4.0	8.0	Q1
TPS622314DRYR	SON	DRY	6	5000	179.0	8.4	1.2	1.65	0.7	4.0	8.0	Q1
TPS622314DRYT	SON	DRY	6	250	179.0	8.4	1.2	1.65	0.7	4.0	8.0	Q1
TPS622315DRYR	SON	DRY	6	5000	179.0	8.4	1.2	1.65	0.7	4.0	8.0	Q1
TPS622315DRYT	SON	DRY	6	250	179.0	8.4	1.2	1.65	0.7	4.0	8.0	Q1
TPS622316DRYR	SON	DRY	6	5000	179.0	8.4	1.2	1.65	0.7	4.0	8.0	Q1
TPS622316DRYT	SON	DRY	6	250	179.0	8.4	1.2	1.65	0.7	4.0	8.0	Q1
TPS622317DRYR	SON	DRY	6	5000	179.0	8.4	1.2	1.65	0.7	4.0	8.0	Q1
TPS622317DRYT	SON	DRY	6	250	179.0	8.4	1.2	1.65	0.7	4.0	8.0	Q1

Device	Package Type	Package Drawing	Pins	SPQ	Reel Diameter (mm)	Reel Width W1 (mm)	A0 (mm)	B0 (mm)	K0 (mm)	P1 (mm)	W (mm)	Pin1 Quadrant
TPS62231DRYR	SON	DRY	6	5000	179.0	8.4	1.2	1.65	0.7	4.0	8.0	Q1
TPS62231DRYT	SON	DRY	6	250	179.0	8.4	1.2	1.65	0.7	4.0	8.0	Q1
TPS62232DRYR	SON	DRY	6	5000	179.0	8.4	1.2	1.65	0.7	4.0	8.0	Q1
TPS62233DRYR	SON	DRY	6	5000	179.0	8.4	1.2	1.65	0.7	4.0	8.0	Q1
TPS62233DRYT	SON	DRY	6	250	179.0	8.4	1.2	1.65	0.7	4.0	8.0	Q1
TPS62234DRYR	SON	DRY	6	5000	179.0	8.4	1.2	1.65	0.7	4.0	8.0	Q1
TPS62234DRYT	SON	DRY	6	250	179.0	8.4	1.2	1.65	0.7	4.0	8.0	Q1
TPS62235DRYR	SON	DRY	6	5000	179.0	8.4	1.2	1.65	0.7	4.0	8.0	Q1
TPS62235DRYT	SON	DRY	6	250	179.0	8.4	1.2	1.65	0.7	4.0	8.0	Q1
TPS62236DRYR	SON	DRY	6	5000	179.0	8.4	1.2	1.65	0.7	4.0	8.0	Q1
TPS62236DRYT	SON	DRY	6	250	179.0	8.4	1.2	1.65	0.7	4.0	8.0	Q1
TPS62237DRYR	SON	DRY	6	5000	179.0	8.4	1.2	1.65	0.7	4.0	8.0	Q1
TPS62237DRYT	SON	DRY	6	250	179.0	8.4	1.2	1.65	0.7	4.0	8.0	Q1
TPS62238DRYR	SON	DRY	6	5000	179.0	8.4	1.2	1.65	0.7	4.0	8.0	Q1
TPS62238DRYT	SON	DRY	6	250	179.0	8.4	1.2	1.65	0.7	4.0	8.0	Q1
TPS62239DRYR	SON	DRY	6	5000	179.0	8.4	1.2	1.65	0.7	4.0	8.0	Q1
TPS62239DRYT	SON	DRY	6	250	179.0	8.4	1.2	1.65	0.7	4.0	8.0	Q1

TAPE AND REEL BOX DIMENSIONS

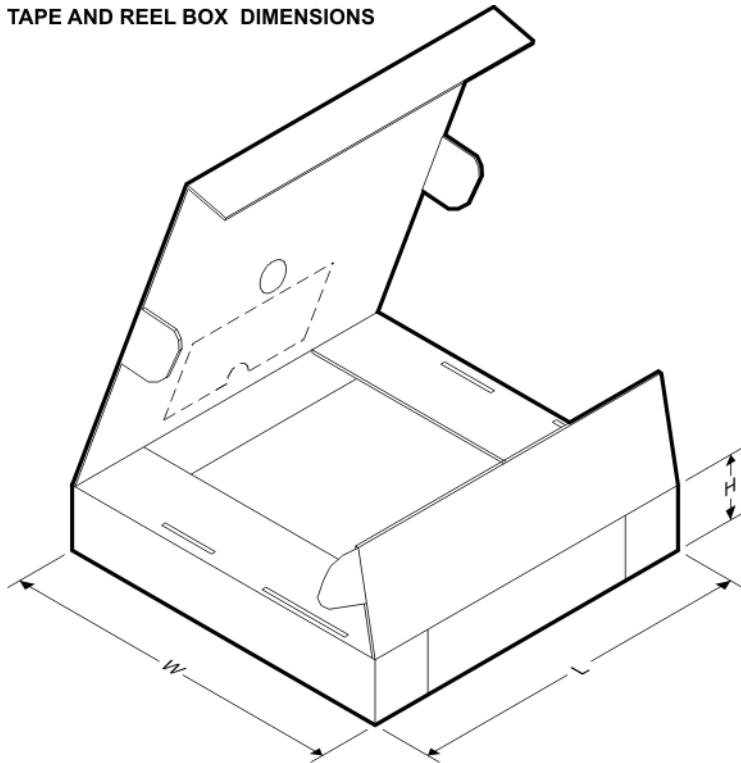

*All dimensions are nominal

Device	Package Type	Package Drawing	Pins	SPQ	Length (mm)	Width (mm)	Height (mm)
TPS62230DRYR	SON	DRY	6	5000	203.0	203.0	35.0
TPS62230DRYT	SON	DRY	6	250	203.0	203.0	35.0
TPS622310DRYR	SON	DRY	6	5000	203.0	203.0	35.0
TPS622310DRYT	SON	DRY	6	250	203.0	203.0	35.0
TPS622311DRYR	SON	DRY	6	5000	203.0	203.0	35.0
TPS622311DRYT	SON	DRY	6	250	203.0	203.0	35.0
TPS622312DRYR	SON	DRY	6	5000	203.0	203.0	35.0
TPS622312DRYT	SON	DRY	6	250	203.0	203.0	35.0
TPS622313DRYR	SON	DRY	6	5000	203.0	203.0	35.0
TPS622313DRYT	SON	DRY	6	250	203.0	203.0	35.0
TPS622314DRYR	SON	DRY	6	5000	203.0	203.0	35.0
TPS622314DRYT	SON	DRY	6	250	203.0	203.0	35.0
TPS622315DRYR	SON	DRY	6	5000	203.0	203.0	35.0
TPS622315DRYT	SON	DRY	6	250	203.0	203.0	35.0
TPS622316DRYR	SON	DRY	6	5000	203.0	203.0	35.0
TPS622316DRYT	SON	DRY	6	250	203.0	203.0	35.0
TPS622317DRYR	SON	DRY	6	5000	203.0	203.0	35.0
TPS622317DRYT	SON	DRY	6	250	203.0	203.0	35.0
TPS62231DRYR	SON	DRY	6	5000	203.0	203.0	35.0
TPS62231DRYT	SON	DRY	6	250	203.0	203.0	35.0
TPS62232DRYR	SON	DRY	6	5000	203.0	203.0	35.0
TPS62233DRYR	SON	DRY	6	5000	203.0	203.0	35.0
TPS62233DRYT	SON	DRY	6	250	203.0	203.0	35.0
TPS62234DRYR	SON	DRY	6	5000	203.0	203.0	35.0
TPS62234DRYT	SON	DRY	6	250	203.0	203.0	35.0
TPS62235DRYR	SON	DRY	6	5000	203.0	203.0	35.0
TPS62235DRYT	SON	DRY	6	250	203.0	203.0	35.0
TPS62236DRYR	SON	DRY	6	5000	203.0	203.0	35.0
TPS62236DRYT	SON	DRY	6	250	203.0	203.0	35.0
TPS62237DRYR	SON	DRY	6	5000	203.0	203.0	35.0
TPS62237DRYT	SON	DRY	6	250	203.0	203.0	35.0
TPS62238DRYR	SON	DRY	6	5000	203.0	203.0	35.0
TPS62238DRYT	SON	DRY	6	250	203.0	203.0	35.0
TPS62239DRYR	SON	DRY	6	5000	203.0	203.0	35.0
TPS62239DRYT	SON	DRY	6	250	203.0	203.0	35.0

DRY (R-PUSON-N6)

PLASTIC SMALL OUTLINE NO-LEAD

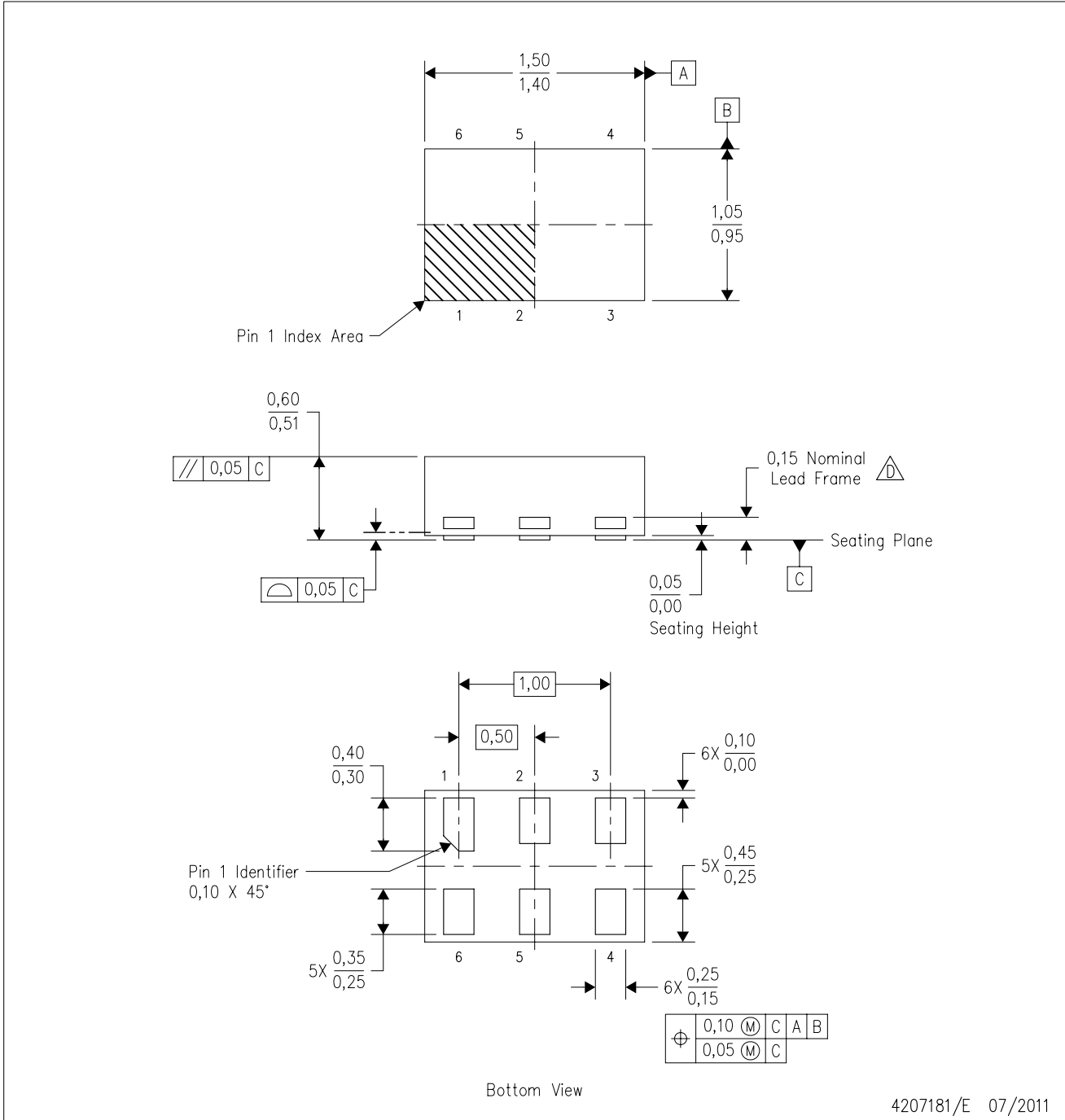

- NOTES:
- A. All linear dimensions are in millimeters. Dimensioning and tolerancing per ASME Y14.5M-1994.
 - B. This drawing is subject to change without notice.
 - C. SON (Small Outline No-Lead) package configuration.
 - △ The exposed lead frame feature on side of package may or may not be present due to alternative lead frame designs.
 - E. This package complies to JEDEC MO-287 variation UFAD.

DRY (S-PUSON-N6)

PLASTIC SMALL OUTLINE NO-LEAD

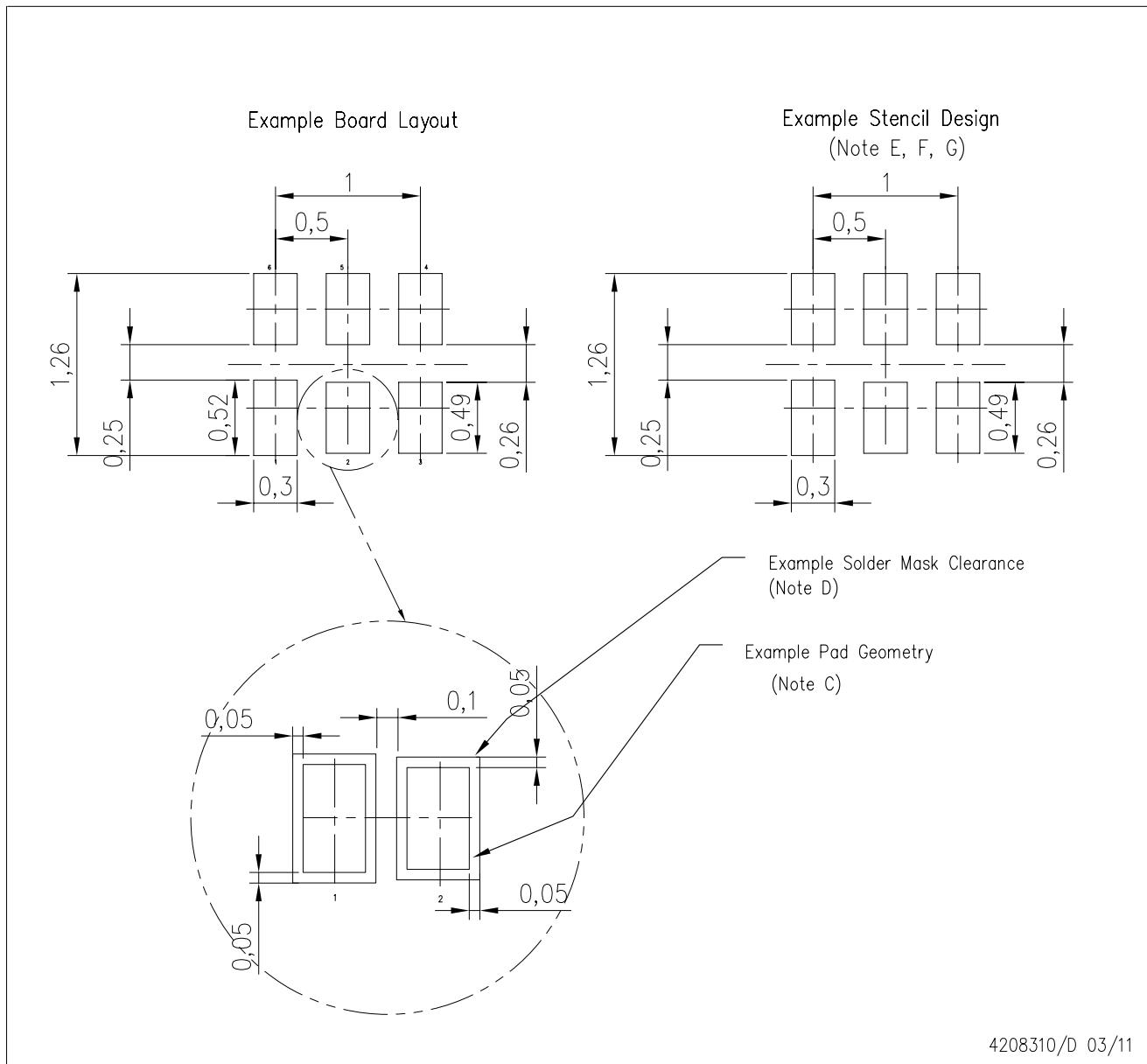

- NOTES:
- All linear dimensions are in millimeters.
 - This drawing is subject to change without notice.
 - Publication IPC-7351 is recommended for alternate designs.
 - Customers should contact their board fabrication site for minimum solder mask web tolerances between signal pads.
 - Maximum stencil thickness 0,127 mm (5 mils). All linear dimensions are in millimeters.
 - Laser cutting apertures with trapezoidal walls and also rounding corners will offer better paste release. Customers should contact their board assembly site for stencil design recommendations. Refer to IPC 7525 for stencil design considerations.
 - Side aperture dimensions over-print land for acceptable area ratio > 0.66. Customer may reduce side aperture dimensions if stencil manufacturing process allows for sufficient release at smaller opening.

IMPORTANT NOTICE

Texas Instruments Incorporated and its subsidiaries (TI) reserve the right to make corrections, modifications, enhancements, improvements, and other changes to its products and services at any time and to discontinue any product or service without notice. Customers should obtain the latest relevant information before placing orders and should verify that such information is current and complete. All products are sold subject to TI's terms and conditions of sale supplied at the time of order acknowledgment.

TI warrants performance of its hardware products to the specifications applicable at the time of sale in accordance with TI's standard warranty. Testing and other quality control techniques are used to the extent TI deems necessary to support this warranty. Except where mandated by government requirements, testing of all parameters of each product is not necessarily performed.

TI assumes no liability for applications assistance or customer product design. Customers are responsible for their products and applications using TI components. To minimize the risks associated with customer products and applications, customers should provide adequate design and operating safeguards.

TI does not warrant or represent that any license, either express or implied, is granted under any TI patent right, copyright, mask work right, or other TI intellectual property right relating to any combination, machine, or process in which TI products or services are used. Information published by TI regarding third-party products or services does not constitute a license from TI to use such products or services or a warranty or endorsement thereof. Use of such information may require a license from a third party under the patents or other intellectual property of the third party, or a license from TI under the patents or other intellectual property of TI.

Reproduction of TI information in TI data books or data sheets is permissible only if reproduction is without alteration and is accompanied by all associated warranties, conditions, limitations, and notices. Reproduction of this information with alteration is an unfair and deceptive business practice. TI is not responsible or liable for such altered documentation. Information of third parties may be subject to additional restrictions.

Resale of TI products or services with statements different from or beyond the parameters stated by TI for that product or service voids all express and any implied warranties for the associated TI product or service and is an unfair and deceptive business practice. TI is not responsible or liable for any such statements.

TI products are not authorized for use in safety-critical applications (such as life support) where a failure of the TI product would reasonably be expected to cause severe personal injury or death, unless officers of the parties have executed an agreement specifically governing such use. Buyers represent that they have all necessary expertise in the safety and regulatory ramifications of their applications, and acknowledge and agree that they are solely responsible for all legal, regulatory and safety-related requirements concerning their products and any use of TI products in such safety-critical applications, notwithstanding any applications-related information or support that may be provided by TI. Further, Buyers must fully indemnify TI and its representatives against any damages arising out of the use of TI products in such safety-critical applications.

TI products are neither designed nor intended for use in military/aerospace applications or environments unless the TI products are specifically designated by TI as military-grade or "enhanced plastic." Only products designated by TI as military-grade meet military specifications. Buyers acknowledge and agree that any such use of TI products which TI has not designated as military-grade is solely at the Buyer's risk, and that they are solely responsible for compliance with all legal and regulatory requirements in connection with such use.

TI products are neither designed nor intended for use in automotive applications or environments unless the specific TI products are designated by TI as compliant with ISO/TS 16949 requirements. Buyers acknowledge and agree that, if they use any non-designated products in automotive applications, TI will not be responsible for any failure to meet such requirements.

Following are URLs where you can obtain information on other Texas Instruments products and application solutions:

Products

Audio	www.ti.com/audio
Amplifiers	amplifier.ti.com
Data Converters	dataconverter.ti.com
DLP® Products	www.dlp.com
DSP	dsp.ti.com
Clocks and Timers	www.ti.com/clocks
Interface	interface.ti.com
Logic	logic.ti.com
Power Mgmt	power.ti.com
Microcontrollers	microcontroller.ti.com
RFID	www.ti-rfid.com
OMAP Mobile Processors	www.ti.com/omap
Wireless Connectivity	www.ti.com/wirelessconnectivity

Applications

Communications and Telecom	www.ti.com/communications
Computers and Peripherals	www.ti.com/computers
Consumer Electronics	www.ti.com/consumer-apps
Energy and Lighting	www.ti.com/energy
Industrial	www.ti.com/industrial
Medical	www.ti.com/medical
Security	www.ti.com/security
Space, Avionics and Defense	www.ti.com/space-avionics-defense
Transportation and Automotive	www.ti.com/automotive
Video and Imaging	www.ti.com/video

TI E2E Community Home Page

e2e.ti.com

Mailing Address: Texas Instruments, Post Office Box 655303, Dallas, Texas 75265
Copyright © 2011, Texas Instruments Incorporated